



BANNER

PRINTING + DISPLAYS



EXHIBITION
& RETAIL DISPLAY
SOLUTIONS



ezybanner.com.au



[ezy banner printing & displays](#)



BANNER DISPLAYS
PAGES 3 - 22



BROCHURE HOLDERS
PAGES 23 - 40



EXHIBITION SYSTEMS
PAGES 41 - 76



**POSTER &
SIGNAGE SYSTEMS**
PAGES 77 - 120



**RETAIL DISPLAYS
& ACCESSORIES**
PAGES 121 - 126



OFFICE DISPLAYS
PAGES 127 - 130



**ELECTRONIC SIGNAGE AND
LIGHTING**
PAGES 131 - 134



Retractable banners	4-9
Banner & poster hangers	10
Retractable banner Accessories	11-12
Banner stands	13-16
Outdoor Banner & Flag systems	17-22

BANNER DISPLAYS

Mark Bric Bannerup Plus

The Bannerup Plus is with no doubt one of the best retractable banner displays available in the world. It is the Perfect banner display for exhibitions, events, conferences & promotion campaigns especially where quality & reliability is a number one priority.

 Turn to page 15 & 16 for BannerUp Plus accessories.

The BannerUp Plus multi height capabilities & range of sizes allows you to get your message out in nearly any size, from 480mm high to 3000mm high & from 250mm wide to 2400mm wide.



Side By Side Connection

The Flat ends allow you to connect systems together to create large backdrops, they also minimise damage if dropped on the ends during transport.



Patented Graphic Quick Change

The patented quick change features allows you to change banners quickly & easily without having the system sent back for banner replacement



Stability

The hideaway swivel feet can easily be accessed for extra stability if needed.



Colours

The BannerUp Plus is now available in Black.



Carry Bag

All BannerUp plus systems include a high quality carry bag.



Easy Tension Adjust

Depending on the material you use you can easily adjust the tension to suit, just use a regular screw driver. It couldn't be easier!

Item No	Width (mm)	Overall Assembled Dimensions (dxhxw)mm	Packed dimensions (dxhxw)mm	Weight	Packing	Warranty
81130	250	140x48x260	140x110x260	2.2kgs	1 per box	10 years
81114	600	140x1860x610	140x110x610	4.5kgs	1 per box	10 years
81115	880	140x2120x890	140x110x890	6kgs	1 per box	10 years
81116	1000	140x2120x1010	140x110x1010	6.5kgs	1 per box	10 years
81117	1200	140x2120x1210	140x110x1210	9kgs	1 per box	10 years
81118	1500	140x2120x1510	140x110x1510	10kgs	1 per box	10 years
81119	2400	140x2120x2410	140x110x2410	18kgs	1 per box	10 years
81126	880 (Black)	140x2120x890	140x110x890	6kgs	1 per box	10 years

Rite Luxus Rollup

- Reliable & Good quality retractable banner system
- Perfect for regular & irregular users
- Anodised Aluminium
- Chrome End Caps
- Wide base – Gives extra stability
- High quality carry bag included
- 5 year warranty



Rite Jewel Rollup

- Sleek endcap & front trim
- Anodised aluminium finish & Satin black
- Quality padded carry bag
- Heavy duty clip top rail
- 2 year warranty



Rite Opal Rollup

- Black endcap for a perfect presentation
- Anodised aluminium finish
- Quality padded carry bag
- Metal pressed base for great durability & strength
- Heavy duty clip top rail
- 3 years warranty



All systems include quality carry bags

Rite Luxus Rollup

Item No	Width (mm)	Overall Assembled Dimensions (dxhxw)mm	Packed Dimensions (dxhxw)mm	Weight	Packing	Warranty
ET1-20	850	250x2200x860	250x50x860	5KGS	5 Per Box	5 Years

Rite Jewel Rollup

Item Code	Description	Size	Height	Packing	Warranty
ET1-160	Rite Jewel Rollup	600mm	1800mm	4 Per Box	2 Years
ET1-161	Rite Jewel Rollup	850mm	2100mm	4 Per Box	2 Years
ET1-162	Rite Jewel Rollup	1000mm	2100mm	4 Per Box	2 Years
ET1-163	Rite Jewel Rollup	1200mm	2100mm	4 Per Box	2 Years
ET1-164	Rite Jewel Rollup	1500mm	2100mm	4 Per Box	2 Years
ET1-165	Rite Jewel Rollup	2000mm	2100mm	4 Per Box	2 Years
ET1-166	Rite Jewel Rollup	3000mm	2100mm	4 Per Box	2 Years
ET1-161B	Rite Jewel Rollup – Black	850	2100mm	4 Per Box	2 Years

Rite Opal Rollup

Item No	Description	Width	Height	Packing	Warranty
ET1-180	Rite Opal Rollup	850	2000	4 Per Box	3 Years

Rite Gem Rollup

- Black end for a perfect presentation
- Anodised aluminium finish
- Quality padded carry bag
- Heavy duty clip toprail
- Double sided
- 2 years warranty



Rite Budget Rollup

- Cost effective
- Very lightweight aluminium system
- Economical to transport
- Anodised Aluminium finish & black
- Ribbed feet for better stability & strength
- Heavy duty clip toprail
- Double sided & single sided options
- Padded Carry Bag included
- 1 year warranty



Rite Basic Rollup

- Anodised aluminium finish with black ends
- Fold out feet for better stability with black ends
- Pole support, stronger to last longer
- Padded Carry Bag
- Clip toprail
- 1 year warranty



Rite Gem Rollup

Item No	Description	Width	Height	Packing	Warranty
ET1-170	Rite Gem Rollup	850	2000	4 Per Box	2 Years

Rite Budget Rollup

Item No	Description	Graphic Size(mm)	Weight	Packing	Warranty
ET1-2C	Single Sided 600	600Wx1800H	2KGS	6 Per Box	1 Year
ET1-1C	Single Sided 850	850Wx2090H	3KGS	6 Per Box	1 Year
ET1-10	Double Sided 850	850Wx2090H	6KGS	4 Per Box	1 Year
ET1-3C	Single Sided 1000	1000Wx2090H	3.5KGS	6 Per Box	1 Year
ET1-5	Single Sided 1200	1200Wx2090H	4.3KGS	6 Per Box	1 Year
ET1-1Bw	Single Sided - Black 850	850W x 2090H	3KGS	6 Per Box	1 Year

Rite Basic Rollup

Item No	Width	Height	Weight	Packing	Warranty
ET1-1000C	850	2000	2.5KGS	6 Per Box	1 YEAR

Mark Bric Bannerup Double Plus



Includes carry bag with wheels



Mark Bric Bannerup Big Plus



Mark Bric Bannerup Double Plus

The Double Sided BannerUp Plus is extremely stable with all the unique features of the single sided bannerup plus. The cassette comes in a padded carrying bag on wheels for ultimate portability.



Double plus quick change

Item No	Width (mm)	Overall Assembled Dimensions (dxhxw)/mm	Packed dimensions (dxhxw)/mm	Weight	Packing	Warranty
81125	880	280x2120x890	280x110x890	14kgs	1 per box	10yrs

Mark Bric Bannerup Big Plus

The Mark Bric Big Plus is available in widths of 1200 & 1500mm. A total height of an impressive 3 metres will make any message stand out in the crowd.



The Big plus units are equipped with extra long support feet for the best possible support

These systems boast all the same features as a standard Mark Bric BannerUp Plus system.

Item No	Width (mm)	Overall Assembled Dimensions (dxhxw)/mm	Packed dimensions (dxhxw)/mm	Weight	Packing	Warranty
81137	1200	140x3000x1210	140x110x1210	9.5kgs	1 per box	10 years
81138	1500	140x3000x1510	140x110x1510	10.5kgs	1 per box	10 years

Bannerup Plus 2400



Mark Bric Bannerup Connectors



Bannerup Plus 2400

The BannerUp Plus 2400 has now made the Bannerup Plus the most complete retractable banner stand series available. The Bannerup Plus 2400 has all the unique features of the standard sizes but comes with the extra long feet for extra stability.

Item No	Width (mm)	Overall Assembled	Packed Dimensions	Weight	Packing	Warranty
81119	2400	140x2120x2410	140x110x2410	18kgs	1 per box	10 years

The BannerUp Plus offers an alternative solution for large back drops. The standard height is 2120mm height (graphic height is 2060mm). If other heights are needed you can simply add extension poles or take poles away.

Mark Bric Bannerup Connectors

The BannerUp Plus is ideal to connect side-by-side to achieve a full size back wall. Thanks to the unique design of the Bannerup Plus, the gap between the banners is kept to a minimum.

Item No	Product Description	Packing
89011	180 Degree Metal Connector	10 Per Bag
89012	135 Degree Metal Connector	10 Per Bag



180 Degree metal connector (top)
135 Degree metal connector

A simple plastic connector is included, free of charge, with the delivery of all BannerUp systems. A Stronger & more secure metal connector can be purchased as an accessory.

Rite Pearl



Rite Eco Rollup



Rite Pearl

- Anodised Aluminium
- Chrome Endcaps
- A4 & A3 size
- Individually boxed

Item No	Width	Height	Weight
ET1-90	210mm	297mm	<1kg
ET1-91	297mm	420mm	<1kg



Rite Eco Rollup

Bamboo is the fastest growing plant on earth & one of our most renewable & sustainable natural resources. It is actually a grass, not a tree – no forests are destroyed to produce bamboo products. Less environmental impact.

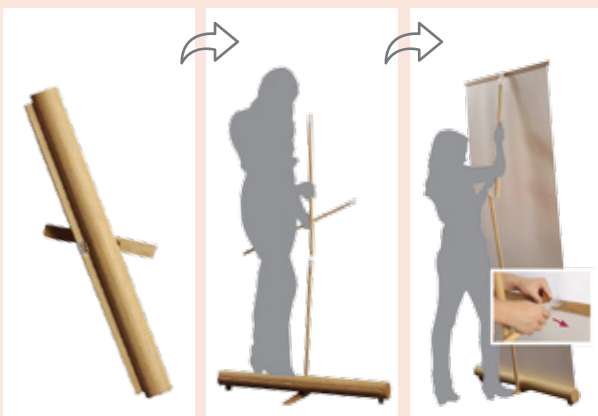

Item	Width (mm)	Overall Assembled Dimensions (dxhwx)mm	Packed Dimensions (dxhwx)mm	Weight	Packing	Warranty
10300	850	220x2150x860	100x120x860	3,5KGS	1 Per Box	1 Year



The material gives a very elegant impression & is extremely durable – comparable to hardwood. Choose bamboo at your next presentation & signal your commitment to sustainability!



Basic Rail



 We cut to size. Please request your custom size.

Mark Bric Aluminium Bannerrail



Visirite Mini Bannerrail



Basic Rail

- Cost effective
- Efficient poster hanger
- Anodised aluminium
- Takes all thin poster medias
- 30mm High



Item No	Width
ET1-110	CUT TO SIZE

Mark Bric Aluminium Bannerrail

The Mark Bric BannerRail provides an attractive & cost effective way to suspend banners & posters in shop windows, malls, banks, travel agencies etc - in places where people are passing by.

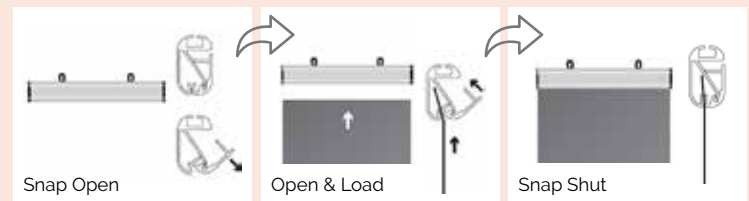

BannerRail Opener to facilitate the opening of the profile.



Join two rails to suspend extra wide banners.

Visirite Mini Bannerrail

The New Slimline Visirite is perfect for hanging large banners.

- Takes a keder edge
- Extra heavy to hold banners taut
- Up to 5m wide
- Available in different colours

Item No	Description	Size
ET4-4100	Slimline Visirite - Mill Finish	35 X 16mm X 5m
ET4-4100	Slimline Visirite - Black	35 X 16mm X 5m
ET4-4200	Slimline Visirite Endcap	
ET4-3060	Visirite Hanger	

Item No	Description
85010	Bannerrail 3100mm Long
85049	Bannerrail suspension hooks
85048	Bannerrail Endcaps

Bannerup Plus Quick-Change Kits



Padded Carrying Bag



Extension Poles



Halogen Spotlight



Bannerup Plus Quick-Change Kits

Easy banner change - a unique patented banner change feature on the Mark Bric Banner Systems allows you to repeatedly use different banners in the one system.



Just slide the old one out & replace it with a new one. In order to do this you will need a Quick-Change kit for each banner. The kit contains one pair of rails (top & bottom)

Padded Carrying Bag

The premium Bannerup Carrying Bag includes extra thick padding which gives shock-proof protection against damage during transport. A convenient shoulder strap is also fitted

Extension Poles

The Extension Poles allow you to increase the banner height. The 1200, 1500 & 2400 systems require 2 poles, all other sizes only 1.

Halogen Spotlight

Focus all attention on your graphics with a Halogen Spotlight!

Item No	Size (mm)
81019	250
81022	600
81020	880
81030	1000
81040	1200
81050	1500
81060	2400

Item No	Size (mm)
5029	600
5020	880
5021	1000
5022	1200
5023	1500

Item No	Product Description
89255	199mm Extension
89256	380mm Extension

Item no	Product Description	Weight	Packing
80015	Halogen Spotlight	500Grams	1 per box

Bannerup Leaflet Holder



Bannerup Hard Case On Wheels



Bannerup Leaflet Holder

In many situations your visual display needs to be accompanied by give-away printed material. BannerUp has the solution for you, an A4 leaflet holder which is attached to the side of the bannerup plus.

This leaflet holder comes with an extra pole & poleholder. It can be folded together & packed in the regular BannerUp Carrying bag or case during transport

Pole holder packs into regular BannerUp Carrying bag



Item no	Product Description	Weight	Packing
89013	A4 Leaflet Holder	850 Grams	1 per box

Bannerup Hard Case On Wheels

The bannerup hard case on wheels is the ultimate way to protect your bannerup plus system. This extra strong Hard shell moulded case is for the 880 system only.

The BannerUp Hard case is equipped with top quality metal locks, built in wheels & comfort grip handle which makes the transport of the BannerUp Plus easy & care free.

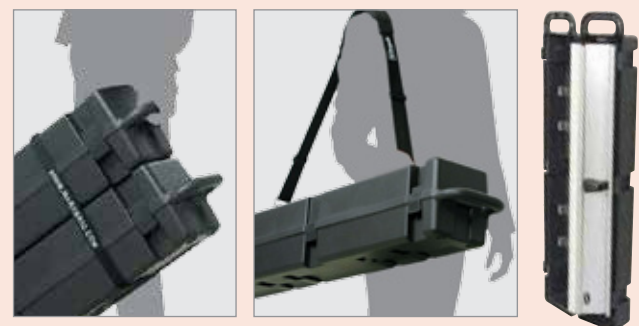

The nesting design allows 2 units to be joined together with tightening straps for easier transport

A Shoulder strap for the hard case is also available

Hardcase

Item no	Product Description	Weight	Packing
5041	880 BannerUp Hard Case	3KGS	1 per box
5042	Shoulder Strap		
5043	Tightening Strap		

Mark Bric Impression



Rite X Display

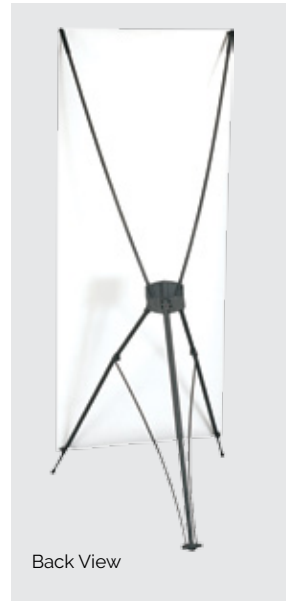

Mark Bric Impression

The impression is a flexible light weight bannerstand! The impression offers full flexibility in graphic width, easy & economical to change graphics & the low weight base provides maximum portability.

Item	Width (mm)	Depth (mm)	Weight	Packing	Warranty
86400	Flexible, use 2 stands for wider graphics than 1200	360	2.5KGS	4 Per Box	5 Years



The foot & pole are manufactured from high quality products



Rear detail



The High quality impression carry bag is an additional extra & can hold a banner at a maximum width of 1150mm



The impression uses the Aluminium BannerRails, there is no need to exchange rails when you change the banners - just simply insert the new banners into the original rails. Quick & Economical

Rite X Display

The Rite X Displays are an extremely light weight portable banner display. Banners can be easily changed & are Attached to the display with eyelets. All sizes come with a carry bag.

Item No	Graphic Size	Weight	Packing
ET1-30	600Wx1600H	1.2KGS	10 Per Box
ET1-35	1200W x 2000H	1.6KGS	10 Per Box



ISOframe Ripple®

1
Two Ripple banner stands



2
Add a flexible link panel



3
A complete 3-section display wall



ISOframe Ripple®

Flexible and extremely cost effective, the ISOframe Ripple will literally change the shape of your portable display experience. The graphic panels can either be attached to a banner stand or used as a flexible link graphic, creating a clean seamless and contemporary portable display wall that provides a strong visual impact.



*Why choose between a banner stand and a pop-up system...
WHEN YOU CAN HAVE BOTH!*

The Ripple wall can be flexed into almost any shape you want and gives you maximum flexibility for reducing or enlarging the size of your display to suit your needs. Add or remove panels one-by-one as desired.

Media screen attachments, spotlights and a unique case/counter solution are available as accessories. Its ability to fit into the boot of a small car makes it ideal for flyaway events and exhibitions.

If simplicity, flexibility, speed of assembly and price competitiveness is what you want from a portable display system then the Ripple ticks all the boxes.



All panels are 800 mm wide.
Standard height 2100 mm.



Flex to almost any shape



Incredibly lightweight and compact

ISOframe Ripple®

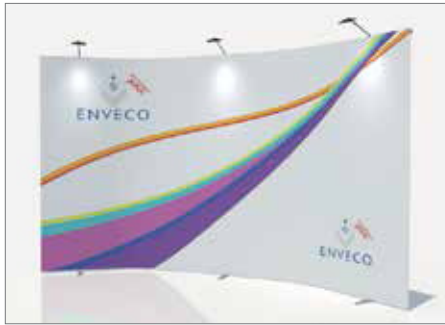

Shape your display as desired

Alternative layouts with a 5-section Ripple display.



The "game-changing" ultra-lightweight linking banner stand system

ISOframe Ripple®

Case to Counter



Shock-proof carry bag with cardboard inner tubing



Insert case into wooden base



Apply the counter top



Wrap around the graphic



Fits into the boot of a small car



Extremely cost effective



No tools needed

Item No	Descriptions	Size	Weight
IS-9800	Ripple Bannerstand	800mmW x 2100mmH	3.1KGS
IS-9802	Ripple Flexilink - Join stands together	800mmW x 2100mmH	0.7KGS
IS-9835	Ripple Screen Holder	VESA 75/100	
IS-SL-LED	LED Spotlight		
IS-5062	Large graphic tube	Fits 3 panel kit	
IS-9836	Counter conversion kit for IS-5062	440mmD x 850mmH	
IS-9803	Kicker & Hanger kit for additional graphics	800mmW	
82281	12mm wide magnet	30m	

Mark Bric Multimaster

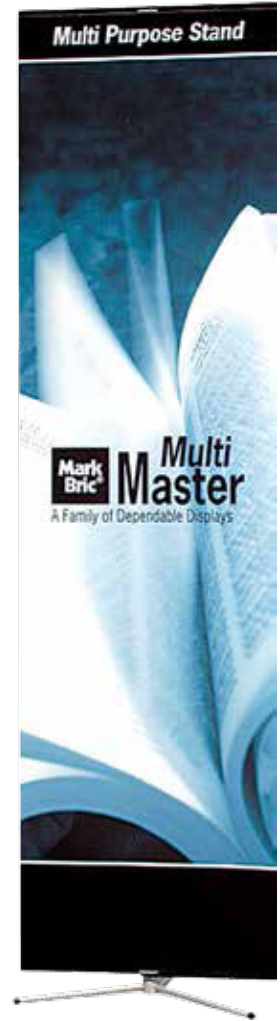

Mark Bric Multimaster

The Multimaster is a multi-purpose display stand which can master graphic banners, plain boards as well as Flexiframe. The Multimaster impresses with a super height up to 3000mm & outstanding stability.

One Stand -Masters Multiple Challenges. Use Snap-Lock BannerRail to secure graphics telescopic pole add height flexibility single & double sided functionality. Message can be lifted from the floor for greater flexibility. Join systems together to create a large back wall includes carry bag



Multimaster Tip: To add graphics to the MultiMaster you will need to add a BannerRail set at your required width, turn to page 10 for details



The MultiMaster can hold graphic boards



The MultiMaster can hold FlexiFrames, turn to page 83 for further info

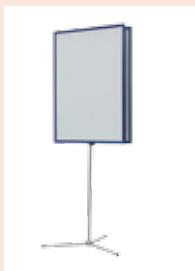

The MultiMaster can be double sided



The Multimaster can hold Banners, just use the BannerRail sets on page 14



The MultiMaster comes with a high quality carry bag that can accommodate graphics up to 1200 wide & the stand

Item No	Width	Assembled Dimensions (dxhwxw)/mm	Weight	Packing	Warranty
86100	Flexible, use 2 stands for wider graphics than 1200	66cm x -x-	3,4KGS	1 Per Box	5 Years

Rite Outdoor Banner Stand



Rite Double Sided Outdoor Rollup



Rite Outdoor Banner Stand

The Rite Outdoor Banner Stand is a great banner display for all weather conditions! The water fill base helps the stand stay upright in even the greatest winds. Each outdoor stand comes with a carry bag making transport as easy as possible!

All components are either aluminium or plastic so you will never experience this system falling foul with jammed or damaged parts due to rust.



Item No	Graphic Size	Weight	Weight Inc Water	Packing
ET1-60	700Wx2100H	5KGS	22KGS	1 Per Box

Rite Double Sided Outdoor Rollup

A great economical solution for outdoor rollups. This system can also be double sided. Fill with water for additional weight & wind resistance, 2 wheels in the base makes it easy to manouvre once weighted. This system can be used either double sided or single sided. Includes carry bag as well!



Item No	Graphic Size(mm)	Weight	Colours	Weight Inc Water
ET1-65	800Wx2090H	18.2KGS	GREY	50KGS

Rite Outdoor Backdrop

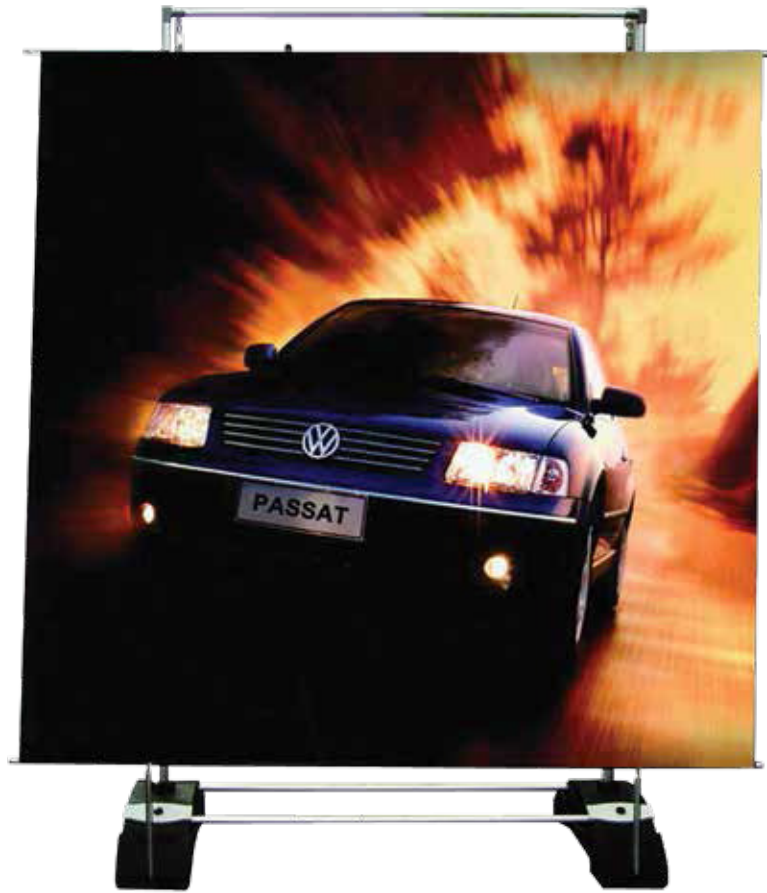

Rite Outdoor Backdrop

The Rite Outdoor Backdrop is an excellent portable display for wide format graphics in outdoor situations. The bases can be filled with water for better stability. With graphics being up to 2500mmw x 2500mmh you can create impressive attention getters in an event situation.

Join systems together to make even larger walls & you can also display graphics on both sides. Each system comes in 2 carry bags.



The graphics are attached with springs to create small movement & catch the eye

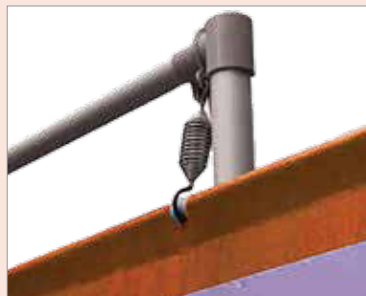

The top of the graphics is also held with springs, the springs also help make the graphics taut & gives greater flexibility with graphics size



You can keep joining systems to create long back walls

Item No	Graphic Size	Weight	Weight inc Water
ET1-55	2500H x 2500W	18.2KGS	50KGS

Rite 5M Flag



The combination of an aluminium & durable plastic structure makes the 5m Flag great for temporary outdoor solutions.

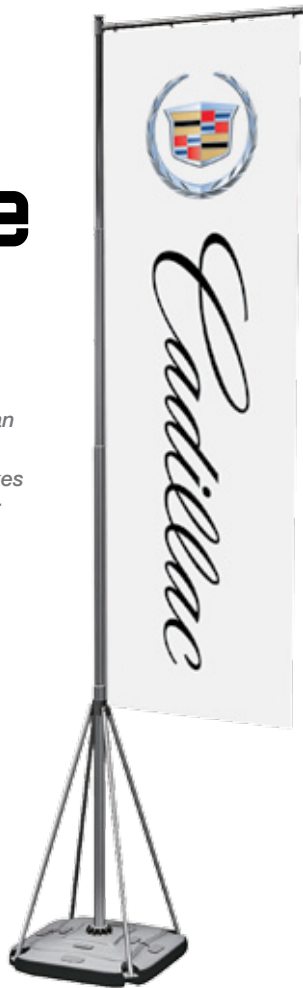

Rite Teardrop Flag



Rite 5M Flag

The 5 Metre Flag is perfect for outdoor events, exhibitions & as high visibility signage. When your client wants to stand out in the crowd you will never get a better solution than the 5m flag. The telescopic pole gives scope for different size flags & banners.

Rite 5m Flag Features:

Water fillable base is aesthetically pleasing & provides extra stability. This banner is held in place utilizing eyelets on the 2 sides. eyelets makes the assembly of the flag quick & easy. If you need to change the banner simply unclip the old banner & replace with the new one. All flags come with carry bags included.



The water fill base comes in 4 sections for ease of transport

Item No	Graphics (mm)	Height (mm)	Weight without water	Weight with water
ET1-50	1000Wx3000H	5000	16KGS	56KGS

Rite Teardrop Flag

The Rite Tear Drop Flags are the perfect attention grabber & great for brand awareness. There are 3 available sizes which all come with grass spikes & carry bags.



The Tear drop flag poles come in three sections plus the spike



A carry bag is included with each flag

Item No	Size	Graphic Size	Weight Inc Water	Packing
ET1-80	2500H	900Wx1800H	2.6KGS	10 Per Box
ET1-81	3400H	1000Wx2400H	2.8KGS	10 Per Box
ET1-82	4400H	1000Wx2400H	3KGS	10 Per Box
ET1-86	OPTIONAL BASE FOR HARD SURFACES			



Weight Bag



Rite Bannerfix - Small

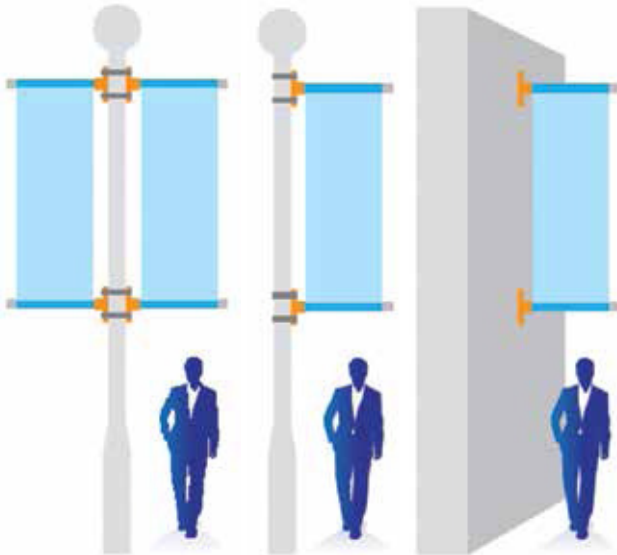

Eye Banner



Rite Bannerfix - Small

Need a solution for hanging banners on poles & external walls? The BannerFix is a quick fix for this situation. You are not limited to any length! Simply attach to a pole with the fixings supplied or screw to the wall. The neatest external Banner fixing system available.

Item No	Description	Width	Packing
ET1-1775	Rite Banner Fix	600mm	1 Per Box



Eye Banner

This banner system is a great attention grabber. It can be fixed to a wall using the wall fixture of the self-adhesive base provided in the kit. Great for shop front exposure. For prices on corporate promotions please contact one of our sales team.

Item No	Description
ACEB	Eye Banner Fittings & Banner

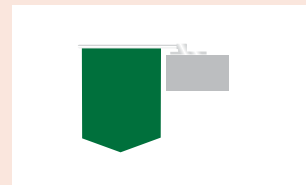
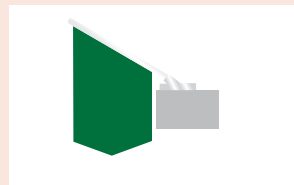
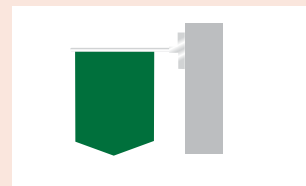
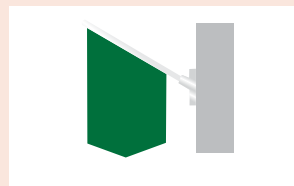

Rite Bannerfix – Large



Banner Tie Back



Rite Bannerfix – Large

The Heavy duty version of our Rite Bannerfix – Small unit, these are great for attaching banners to poles or buildings.

It is important to think about the exposure to wind, location and how you will fix these to the pole or building. There are many factors that you need to consider when attaching banners to structures as they significantly increase wind load, you can reduce the load by reducing the length of banner.

Item No	Description	Width	Packing
ET1-1776	Rite Banner Fix	750mm	1 per box
ET1-1777	Rite Banner Fix	900mm	1 per box

Banner Tie Back

The banner tie back is perfect for tying back banners to poles and walls where there may not be a tie point.

Used especially where you may want to use springs or products other than rope.

Item No	Description
ET1-1779	Aluminium Tie Back

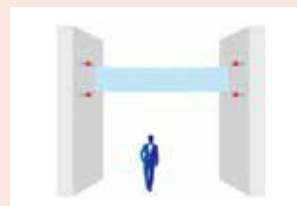

Bannerbeast



Bannerbeast

The Bannerbeast is designed to hold your outdoor banners perfectly taut in all outdoor situations.

They are great for beach banners and any outdoor event. Its designed to replace the dangerous and ugly star pickets.

Product features:

- Available in 2 sizes
- Folds up and fits neatly into a provided carry bag
- Setup requires no tools
- Banner attachments included
- Black finish
- 2 base options available
- 12 month warranty

ITEM CODE	DESCRIPTION	BANNERSIZE	WEIGHT	FOLDED SIZE
ET1-83	Bannerbeast	2450mmW x 1220mmH	3.1KGS	250x50x1430mm
ET1-84	XL Banner beast	2450mmW x 2440mmH	3.33KGS	250x50x1430mm
ET1-85	Hard surface base		3.2KGS	
Et1-87	Grass Spike		1.2KGS	



Portable Brochure stands	24-25
Freestanding Brochure displays	26-27
Ipad display	27
Individual brochure holders	28-30
Wall Mounted Brochure systems	31-33
Weatherproof Brochure holders	33
Brochure Holder cabinets	33
Brochure Holder Counter modules	34-36
Rotating Brochure displays	37
Foyer Brochure stands	38
Postcard stands	39
Business Card holders	40

BROCHURE HOLDERS

Mark Bric Swingup



Mark Bric Swingup

Our premium portable literature rack organises & displays brochures, flyers & catalogues in the most efficient & organised manner. The 5 shelf literature rack comes flat packed in a strong nylon bag & unfolds in seconds.

Extremely user friendly! An extra support at the back for increased stability, secure double locking, superb durability & a 5 YEAR WARRANTY are some of the features that make the SwingUp standout! Available in either silver grey or matt black.



SwingUp Shelf Divider



SwingUp Flexiframe Header



Carry Bag on Wheels

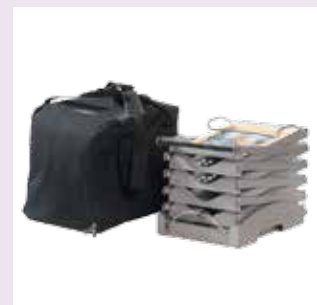

Folded SwingUp

Item No	Description	Width (mm)	Assembled Dimensions (dxhwx)mm	Weight	Capacity	Warranty
83020B	SwingUp With Carry Bag – Black	240	1685 x 290 x 290	8.9kgs	40mm	5 Years
83020S	SwingUp With Carry Bag – Silver	240	1685 x 290 x 290	8.9Kgs	40mm	5 Years
83025B	SwingUp With Carry Bag On Wheels - Black	240	1685 x 290 x 290	10.2Kgs	40mm	5 Years
83025S	SwingUp With Carry Bag On Wheels – Silver	240	1685 x 290 x 290	10.2Kgs	40mm	5 Years
83033L	SwingUp Header Connection – A4 Landscape				5 Years	
83033P	SwingUp Header Connection – A4 Portrait				5 Years	
83032	SwingUp Shelf Divider				5 Years	

Rite Flyer



Rite Flyer

Fly Up, Fly Down, Fly Out - The Rite Flyer display for all your portable exhibition, showroom & retail situations. The light weight & easy user functions makes this flyer display a joy to use. Ergonomic & aesthetic looks make your flyers look even better!



Item No	Description	Assembled Dimensions (dxhxw)/mm	Packing	Weight
ET2-80	Rite Flyer	350x1500x250	1 Per Box	12KGS

Rite Freestanding Display



Possible Configurations

Rite Freestanding Display

The Rite Freestanding Display is an extremely versatile display which can display a combination of brochures & Posters. This display is also capable of being double sided! The finish is anodised aluminium.

 You can choose any combination of brochure shelves & Snap frame poster holders to suit your requirement e.g. 1 Brochure Shelf & 1 Snap frame, 1 Snap frame & 2 Brochure Shelves etc.

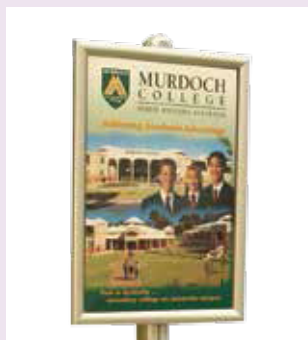

A2 SnapFrame



A3 Landscape Literature shelf



Item No	Description	Assembled Dimensions (dxhwx)mm	Capacity (Size & Depth)	Weight
ET2-2	Pole & Base	400x1800x400		12KGS
ET2-3	Literature Shelf		A3 Landscape 40mm	2KGS
ET2-1	A2 SnapFrame		A2 Poster, 420x594	1.5KGS

Rite Pedestal Brochure Stand



Rite Ipad Display



Rite Pedestal Brochure Stand

The Rite Pedestal Brochure Stand is the ultimate Brochure stand for any showroom or retail outlet. It Makes access to your promotional material easy & on hand for all customers.

Item no	Size	Assembled Dimensions (dxhwxw)mm	Weight	Packing
ET2-10	A4 Portrait	250x1000x350	6KGS	1 Per Box
ET2-11	A4 Landscape	350x1000x350	6KGS	1 Per Box



Rite Ipad Display

Two different models are available, one floor stand and one counter top version (ideal to combine with the Expo Case). Both stands are of top quality with outstanding stability, easy to assemble, anti-theft secured and fits all iPad models: 2/3/4/air. The floor stand is height adjustable between 70-110 cm. Last but not least, they are very competitively priced!

Item No	Description	Warranty
ET2-111	Wall Mount - iPad	1 Year
10514	Free Standing - iPad	1 Year
10515	Counter - iPad	

Classik System

A fully integrated system – offering the flexibility and versatility to continually expand or change. Full height support – to prevent brochures from flipping forward. Easy to clean holders individually. Flexible uses – wall system – carousel stand – entrance display – counter display system

 *The most unique brochure display system!*

Universal Base Bracket

PUBB 01

Combines with all Classik brochure holders to form a free standing desk unit. Provides support for wall mounted systems.



Slat Wall/Peg Board Bracket

PSW/PB 01

This bracket fits all brochure holders and enables holders to be fitted to slat wall or peg board.



Z Stand

PZS 01

Provides support when combining brochure holder together, to form a desk top display



Universal Wall Bracket

PUWB 01

Combines with all Classik brochure holders for wall mounting.



Slat Wall Clip

PSWC 01

Combines with all Classik brochure holders to mount on slat wall



Flopper Stopper

PFS 01

Prevents light weight A4 literature from falling through middle of brochure holder.



**Brochures Displays -
The Right Way!**

Brochure Holders without Tabs

May be used as single desktop displays (note: must be combined with universal base bracket) – or fixed to flat surfaces (wall etc)

Brochure Holders with Tabs

Clips onto other Classik holders with tabs to form wall, carousels and entrance displays.



Trifold Holder without Tabs

PBHFB 03

Inside Dimensions:
105W x 200H x 25D (mm)

Outside Dimensions:
112W x 202H x 31D (mm)



Trifold Holder with Tabs

PBH 03

Inside Dimensions:
105W x 200H x 25D (mm)

Outside Dimensions:
112W x 202H x 31D (mm)



A5 Brochure Holder without Tabs

PBHFB 05

Inside Dimensions:
150W x 200H x 25D (mm)

Outside Dimensions:
155W x 202H x 31D (mm)



A5 Brochure Holder with Tabs

PBH 05

Inside Dimensions:
150W x 200H x 25D (mm)

Outside Dimensions:
155W x 202H x 31D (mm)



A4 Brochure Holder without Tabs

PBHFB 04

Inside Dimensions:
218W x 285H x 25D (mm)

Outside Dimensions:
225W x 287H x 31D (mm)



A4 Brochure Holder with Tabs

PBH 04

Inside Dimensions:
218W x 285H x 25D (mm)

Outside Dimensions:
225W x 287H x 31D (mm)



Aluminium Wall Bar

PAWB

This product is easily screwed to a wall and the Classik brochure holders (with Tabs) can be hung on it to create a wall display.

Mounting diagram showing aluminium wall bar with standard base bracket for wall support.

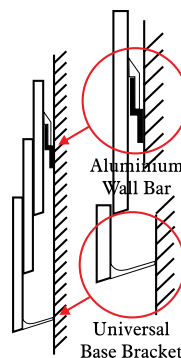

A Class

- An extensive range of brochure holders designed to provide the perfect solution for all your promotional display needs
- Single piece construction of many items for strength and durability
- All products can be personalized with your own company logo or sales message at minimal cost
- This system is good for wider brochures with binding



Place your brochure in clear view!



Plastic Clip

TPCL

Allows single DL, A5 and A4 brochure holders to be clipped together to form a wall system.



DL Brochure Holder

TBH 03

Inside Dimensions:
104W x 147H x 32D (mm)

Extra Deep DL Holder

ACDDL

(60mm deep)



Counter Stand Base

TAB 01

This bracket suits all Taymar single brochure holders. It allows single holders to be changed into counter standing units.



A5 Brochure Holder

TBH 05

Inside Dimensions:
161W x 187H x 32D (mm)

Extra Deep A5 Holder

ACDA5

(60mm deep)



Divider for A4 Pockets

TPD 01

This divider allows you to change the A4 holder to accommodate two DLs.



A4 Brochure Holder

TBH 04

Inside Dimensions:
231W x 240H x 32D (mm)

Extra Deep A4 Holder

ACDA4

(60mm deep)



Styrene Slat Wall Bracket (pair)

TSWB 01

To attach brochure holders to slat wall.

A Class – Individual Components:

Order Code	Description
TPCL	Plastic Clip
TAB 01	Counter Stand Base
TPD 01	Divider for A4 Pockets
TSWB 01	Styrene Slat Wall Bracket (pair)
TBH 03	DL Brochure Holder
ACDDL	Extra Deep DL Holder(60mm deep)
TBH 05	A5 Brochure Holder
ACDA5	Extra Deep A5 Holder(60mm deep)
TBH 04	A4 Brochure Holder
ACDA4	Extra Deep A4 Holder(60mm deep)

Classik – Wall Mounted Systems



Designed to compliment your corporate environment!

- Attractive Wall Displays for maximum impact
- Easy to erect kit combination
- Cost effective
- Can be made to any width – 6 metres and beyond
- Pragmatic Modular Design that allows unlimited variations
- Easily expandable to suit various requirements.



8 A4 Holders

PWA 8/4

Measurements:
Width: 450mm
Height: 755mm
Depth: 140mm



16 A4 Holders

PWA 16/4

Measurements:
Width: 905mm
Height: 755mm
Depth: 140mm



4 A4 / 8 DL Holders

PWA 4/4 8/3

Measurements:
Width: 450mm
Height: 680mm
Depth: 140mm



8 A4 / 16 DL Holders

PWA 8/4 16/3

Measurements:
Width: 905mm
Height: 680mm
Depth: 140mm



16 DL Holders

PWA 16/3

Measurements:
Width: 450mm
Height: 560mm
Depth: 140mm



32 DL Holders

PWA 32/3

Measurements:
Width: 905mm
Height: 680mm
Depth: 140mm

Classik – Wall Mounted Systems

 *Designed to compliment your corporate environment!*

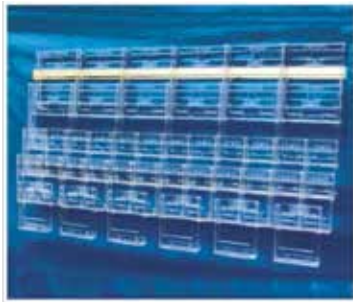

12 A4 / 24 DL / 6 A5 Holders

PWA 12/4 24/3 6/5

Measurements:
Width: 1360mm
Height: 800mm
Depth: 170mm



12 A5 Holders

PWA 12/5

Measurements:
Width: 470mm
Height: 560mm
Depth: 140mm

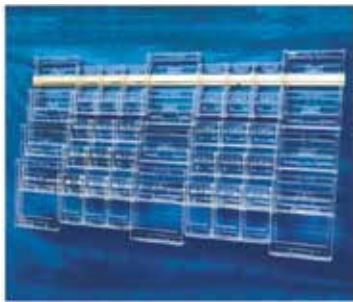

12 A4 / 30 DL Holders

PWA 12/4 30/3

Measurements:
Width: 1360mm
Height: 680mm
Depth: 140mm



8 A4 / 10 A5 / 10 DL Holders

PWA 8/4 10/5 10/3

Measurements:
Width: 1800mm
Height: 700mm
Depth: 140mm



80 DL Holders

PWA 80/3

Measurements:
Width: 1800mm
Height: 700mm
Depth: 140mm



6 A4 / 16 A5 / 32 DL Holders

PWA 6/4 16/5 32/3

Measurements:
Width: 995mm
Height: 1080mm
Depth: 140mm



Can't find what you're looking for?
If your preferred combination is not presented in this catalogue, please speak to one of our helpful sales team, so we can make up a kit according to your requirements.

A Class – Wall Displays



Designed to compliment your corporate environment!



10 A4 Pockets
ACVWA 10/4
Measurements:
Width: 228mm
Height: 1120mm
Depth: 135mm



6 A4 Pockets
ACVWA 6/4
Measurements:
Width: 228mm
Height: 750mm
Depth: 135mm



3 Tier A4 Wall Display
TWD 3/4
Another option for displaying your A4 literature.



4 Wide DL Brochure Display
TWD 4/3
Ideal as a wall or counter display (when combined with A Class base stand – see page 34 – TAB 01)



Weather Proof Display
ACVWA 10/4 (A4 size)
ACWP 05 (A5 size)
ACWP 03 (DL size)



Rite Weatherproof Literature Display (A4 size)
ACWP 04DF
Measurements:
Width: 228mm
Height: 750mm
Depth: 135mm

Timber Entrance Displays:

Option 1:

The standard mobile entrance display can have timber finished ends incorporated for that extra quality image.

Description

- Single – sided entrance displays
- Double – sided entrance displays

Option 2

The standard mobile entrance display can have timber finished ends and a storage cabinet with a sliding door, for that extra quality image.

Description

- Single – sided entrance displays
- Double – sided entrance displays



Timber Finish Options

Jarrah and Golden Beech - please enquire regarding other colour / timber finish options



Option 1



Option 2

RITE - Counter Displays

- Single piece construction
- Available in single or multi-tier styles
- Clear

 A range that is effective and economical!



Counter Display – Single Tier

TSBH 1-3 (Single Tier DL)
Pocket is 30mm deep

TSBH 1-5 (Single Tier A5)
Pocket is 30mm deep

TSBH 1-4 (Single Tier A4)
Pocket is 30mm deep



Counter Display – 4 Tier

TSBH 4-5 (4 Tier A5 Holder)
Pocket is 30mm deep

TSBH 4-3 (4 Tier DL Holder)
Pocket is 30mm deep



Counter Display – 3 Tier

TSBH 3-4 (3 Tier A4 Holder)
Pocket is 30mm deep



Two 4 tier DL brochure displays joined together with a header attached

RITE – Brochure Displays:

Order Code	Description	Qty
TSBH 1-3	Single Tier DL Holder	1-99
TSBH 1-5	Single Tier A5 Holder	1-99
TSBH 1-4	Single Tier A4 Holder	1-99
TSBH 4-5	4 Tier A5 Holder	1-99
TSBH 4-3	4 Tier DL Holder	1-99
TSBH 3-4	3 Tier A4 Holder	1-99

A Class - Counter Displays



4 Tier DL Brochure Display

TBH 4P 03

Measurements:
Width: 110mm
Height: 260mm
Depth: 180mm

A compact display which presents DL brochures well.



4 Tier Landscape A4 Brochure Display

TBHL 4P 04



4 Tier A5 Brochure Display

TBH 4P 05

Measurements:
Width: 160mm
Height: 260mm
Depth: 180mm

An effective way of displaying A5 brochures.



Landscape Brochure Displays

TBCH L03 (DL Size)

TBCH L04 (A4 Size)



4 Tier A4 Brochure Display

TBH 4P 04

Measurements:
Width: 237mm
Height: 345mm
Depth: 200mm

An excellent single-piece display for counter use

Classik - Counter Displays

- Sturdy, light-weight aluminium frame
- Full height support for brochures
- Many combinations
- Unique in Design.... Unique in Quality

 *The most economical way to display your brochures!*



4 A4 Display

PCD 4/04

Measurements:
 Width: 450mm
 Height: 450mm
 Depth: 120mm
 Displays 4 A4 brochures.



8 DL / 2 A4 Display

PCD 8/03 2/04

Measurements:
 Width: 450mm
 Height: 520mm
 Depth: 165mm
 Displays 8 DL and 2 A4 brochures.



12 DL Display

PCD 12/03

Measurements:
 Width: 440mm
 Height: 430mm
 Depth: 155mm
 Displays 12 DL brochures.



16 DL / 4 A4 Display

PCD 16/03 4/04

Measurements:
 Width: 900mm
 Height: 520mm
 Depth: 165mm
 Displays 16 DL and 4 A4 brochures.



3 DL / 6 A5 Display

PCD 3/03 6/05

Measurements:
 Width: 450mm
 Height: 520mm
 Depth: 165mm
 Displays 3 DL and 6 A5 brochures.



9 A5 Display

PCD 9/05

Measurements:
 Width: 465mm
 Height: 430mm
 Depth: 155mm
 Displays 9 different A5 brochures.

Classik - Rotating Displays

- One piece base for extra stability
- Fully adjustable height location for brochure levels
- Extra brochure holders can be added as required (A4, A5 & DL)
- Full height support prevents brochures from flipping forward

 *The most versatile rotating brochure display!*



4 Level / 48 DL Holders

PCS 48/3

This stand is able to hold 48 different brochures. There are 12 DL brochure holders on each level.



3 Level / 18 A4 Holders

PCS 18/4

Each level holds 6 A4 brochure holders



3 Level / 18 A4, 36 DL Holders

PCS 18/4 36/3

Each level holds 6 A4 and 12 DL brochures.



3 Level / 72 DL Holders

PCS 72/3

This stand is able to hold 72 different brochures. There are 24 DL brochure holders on each level.



Can't find what you're looking for?

If your preferred combination is not presented, please speak to us, so we can make up a display according to your requirements.

RITE - Literature Racks

- Easy to disassemble for transportation
- All holders have interconnecting tabs for ease of assembly
- Excellent use as a corner display unit
- All individual holders have FULL HEIGHT SUPPORT to prevent leaflets from flipping forward
- Standard colour is APO grey
- Various combinations

 *Designed to compliment your corporate environment!*



**4 A4 / 8 DL
foyer stand**
PFS 4/4 8/3
4 A4 and 8 DL
brochure holders



**8 A4 / 16 DL
foyer stand**
PFS 8/4 16/3
8 A4 and 16 DL
brochure holders



**6 A4 foyer
stand**
PFS 6/4
6 A4 brochure
holders



**16 A4 foyer
stand**
PFS 16/4
16 A4 brochure
holders



**24 A5 foyer
stand**
PFS 24/5
24 A5 brochure
holders



**32 DL Foyer
Stand**
PFS 32/3
32 DL brochure
holders

Classik Postcard Displays

- Easy to assemble • Modular design so system can be added on to or taken off according to your requirements
- This system displays landscape styled postcards which are 170 x 105mm or portrait style postcards which are 115 x 170mm



Display your postcards in the most effective way!



Universal Base Brackets
PUBB 01

This bracket fits to postcard holders and enables them to be converted to a counter display unit.



Landscape Postcard Holder
PPCH L

Classik Portrait Postcard Holder
PPCH P



Counter Postcard Display
PPCH-C24

This display can accommodate 24 different post cards.



Wall Mounted Postcard Display
PPCH-W24

Wall display with 24 different card holders. Supplied with wall bar and universal base brackets



Postcard Carousel
PPCH-C54

This carousel stand holds 54 different postcards.

- Easy to assemble
- The three levels are fully adjustable
- Header card holder suits card up to 6mm



Classik Stand Postcard Display are available in:

- Desktop displays
- Wall displays
- Entrance displays
- Foyer stands • Carousels

Business Card Displays

A Class Business Card Holders:



Landscape Business Card Holder
TBCH L

Portrait Business Card Holder
TBCH P



4 Pocket Business Card Holder
TBCH 4TL

Classik Business Card Holders:



Portrait Clip On Business Card Holder
PBCH AP

Landscape Clip On Business Card Holder
PBCH AL

Clip-on to "Classik" range of brochure holders.



Wall Mounted Business Card Display
PDO BCH-60



Portrait Counter Business Card Holder
PBCH BP

Landscape Counter Business Card Holder
PBCH BL

Counter Business Card holders.



Wall Mounted Business Card Display
PBCH - W16



Portrait Single Business Card Holder
ACBCHP

Landscape Single Business Card Holder
ACBCHL

Ideal as a stand alone identification card display



Counter Business Card Display
PBCH-C12

Counter display for up to 12 different cards.



Flexiframe Displays	42-47
Flexiframe Accessories	48
Popup Displays	49 - 53
Popup Cases	54
Popup Accessories	55
Popup Ideas	56
Exhibition Counters	57-59
EGO Exhibit	60-63
Isoframe	64-71
Isobar counter	72-73
Fabric Systems	74 - 76

EXHIBITION SYSTEMS

Mark Bric Flexiframe



1



2



3



4

Mark Bric Flexiframe

Flexiframe is the ultimate graphic display solution for all your retail, corporate & exhibition display needs. Possible configurations, design & layouts are endless plus the choice of colour make the opportunities almost infinite.

Renting from an exhibition company is usually very expensive & even more of a problem – your stand will look like all the other exhibitors.

Purchasing a Flexiframe system makes good economic sense & will really make you stand out in the crowd. Most organisations would have covered the cost of the purchase by the second exhibition, as compared with renting.

The flexibility of the Flexiframe means you can also use the system between the exhibitions & trade shows in its original form or readjusted to suit your display area such as the reception or showroom in your company... all by using the same panels.



One of the world's most versatile display & exhibition systems!

We offer the Flexiframe in 4 different forms

- 1 Basic Flexiframe Kits
- 2 Advanced Flexiframe Kits
- 3 Custom designed Kits
- 4 Build your own Kits

Velcro Panel Displays



Velcro Panel Displays

The Velcro Panel Displays are a very portable display system for displaying various different poster sizes & information leaflets. They are commonly used by community centres here the latest news can be pinned up or attached easily & efficiently.

Each system comes with:

- Carry Bags (except the add on 2 panel)
- Connectors for backwall (connectors are available for different configurations)
- Instructions
- Panels (700mm x 1000mm)
- Optional headers (700mm x 300mm)

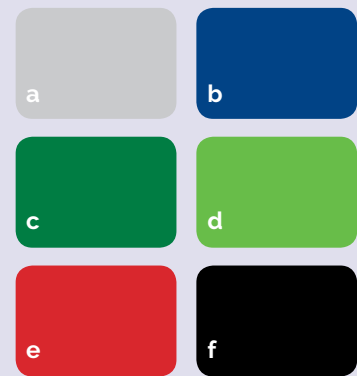

Each panel is approx 700mmW x 1000mmH & is extremely lightweight but rigid & strong. Panels can be placed in a portrait or Landscape format. Each panel is covered with velcro receptable fabric on both sides. You can choose between 6 different fabric colours & 16 different frame colours.

Item No	Description	Size(wxh)	Weight(approx)
ET3-1001	6 Panel Display	2190mm x 2060mm	13KGS
ET3-1002	6 Panel Display with Headers	2190mm x 2390mm	17.5KGS
ET3-1003	8 Panel Display	2920mm x 2060mm	16KGS
ET3-1004	8 Panel Display with Headers	2920mm x 2390mm	22KGS
ET3-1005	10 Panel Display	3650mm x 2060mm	26.5KGS
ET3-1006	10 Panel Display with Headers	3650mm x 2390mm	26.5KGS
ET3-1007	Add on 2 Panel Kit	730mm x 2060mm	3.5KGS
ET3-1008	Add on 2 Panel Kit with Headers	730mm x 2390mm	4KGS

Standard Flexiframe Systems

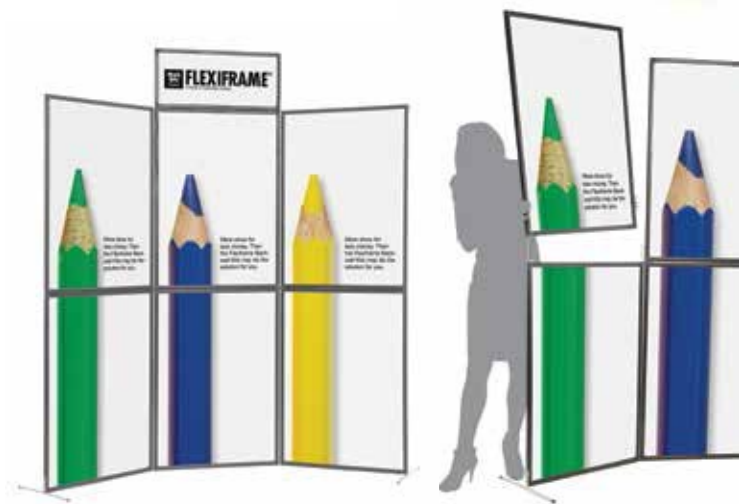

Standard Flexiframe Systems

The Flexiframe Systems can be purchased with frames only so you or your client can insert your own graphic panels. We highly recommend 5mm gatorfoam as the insert & if you want to just insert a poster you need to sandwich them between 2 pieces of clear plastic.

All systems include

- Carry bags & connectors.
- You can choose your own frame colour to match your clients corporate colours

Item No	Description	Size(w x h)
6000	Basic 3	2190mm x 1030mm
6005	Headers for Basic 3	2190mm x 1030mm x 330mm
6001	Basic 4	1460mm x 2060mm
6006	Headers for Basic 4	1460mm x 2060mm + 330mm
6002	Basic 6	2190mm x 2060mm
6007	Headers for Basic 6	2190mm x 2060mm + 330mm
6003	Basic 8	2920mm x 2060mm
6008	Headers for Basic 8	2920 x 2060mm + 330mm
6004	Basic 10	3650mm x 2060mm
6009	Headers for Basic 10	3650mm x 2060mm + 330mm
6005	Add on Basic	730mm x 2060mm
6010	Headers for Add on Basic	730mm x 2060mm + 330mm

Square Flexiframe Tables



Triangular Flexiframe Tables



Flexiframe Folding Demonstration Table



Square Flexiframe Tables

The Flexiframe Tables are very strong & portable. All frames except a 5mm thick panel. You can choose your frame colour. The tops are metal.

Item No	Size (mm)
6120	500W x 500L x 530H
6121	500W x 500L x 730H
6124	700W x 700L x 730H
6125	700W x 700L x 1030H

Triangular Flexiframe Tables

The complete system can pack down into a small box, it is very cost efficient to transport. All frames except a 5mm thick panel. You can choose your frame colour.

Item No	Size (mm)
6110	500W x 500L x 500D x 530H
6111	500W x 500L x 500D x 730H
6112	700W x 700L x 700D x 730H



The complete system can pack down into a small box, it is very cost efficient to transport. The tops are metal.

Flexiframe Folding Demonstration Table

The counter unit includes a front frame with the size of 700 X 1000 & 2 end frames with the size of 300 x 1000mm. The inner shelves are all aluminium & the Table top is natural timber.

Item No	Size (mm)
6104	790W x 410L x 1030H

Triangular Flexiframe Towers



Square Flexiframe Towers



Hexagon Flexiframe Towers



Threeway & Fourway Flexiframe Towers

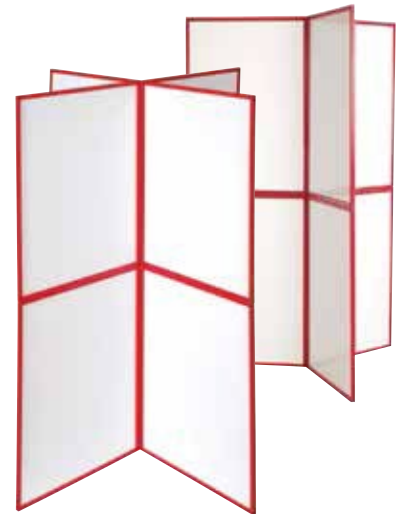

Triangular Flexiframe Towers

A very stable 3 sided display. The Triangular Flexiframe Tower is lightweight & can be folded down to make this display extremely portable. The system is supplied with the frames only so you can insert your own panel.

Item No	Description	Size (w x h)
6200	Triangular Flexiframe Towers	730mm x 2060mm
6210	Headers for Triangular Tower	730mm x 2060mm + 330mm

Square Flexiframe Towers

A very stable 4 sided display. The Square Flexiframe Tower is lightweight & can be folded down to make this display extremely portable. The system is supplied with the frames only so you can insert your own panel.

Item No	Description	Size (w x h)
6201	Square Flexiframe Towers	730mm x 2060mm
6211	Headers for Square Tower	730mm x 2060mm + 330mm

Hexagon Flexiframe Towers

A very stable 6 sided display. The Hexagon Flexiframe tower is lightweight & can be folded down to make this display extremely portable. The system is supplied with the frames only so you can insert your own panel.

Item No	Description	Size (w x h)
6200	Hexagon Flexiframe Towers	1400mm x 2060mm
6203	Hexagon Flexiframe Towers	1400mm x 3090mm
6204	Hexagon Flexiframe Towers	1400mm x 4120mm
6212	Hexagon Flexiframe Towers	1400mm x 4120 + 330mm

Threeway & Fourway Flexiframe Towers

Very stable 6 & 8 sided displays. The Three way & Four way Flexiframe cross are lightweight & can be folded down to make the displays extremely portable. The systems are supplied with the frames only so you can insert your own panel.

Item No	Description	Size (w x h)
6206	Four way Flexiframe Cross	1400mm x 2060mm
6214	Headers for Four way Cross	1400mm x 2060mm + 330mm
6205	Three way Flexiframe Cross	1400mm x 2060mm
6213	Headers for Three way Cross	1400mm x 2060mm + 330mm

Custom Designed Flexiframe Kits

Flexiframe is so flexible! With some imagination you can come up with some unique display, exhibition & promotional displays for your clients. the following projects have been completed with Flexiframe:



Flexibility: Email us or fax us your ideas & we can turn them into a reality with Flexiframe.

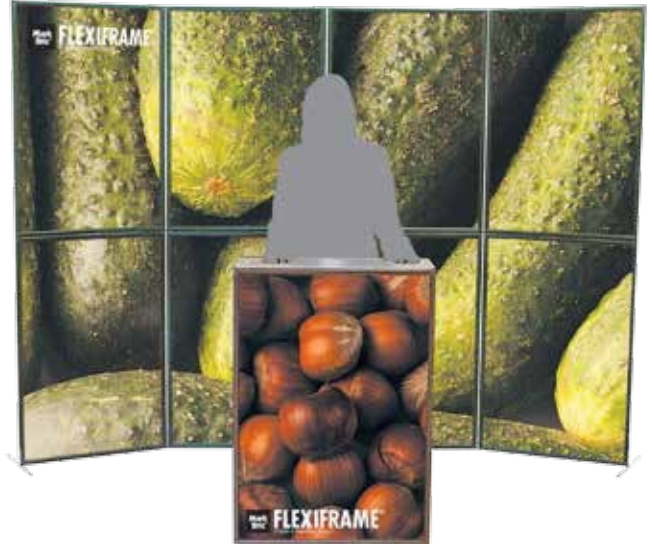

Spotlight



Brochure Shelves



Hard Plastic Transport Case



Carry Bags For Panels



Spotlight

Brighten Your Display With Spotlights!



Item No	Description
80015	50W Halogen Spotlight
80021	LED Spotlight
80007	LED Spotlight Connector

Brochure Shelves

Display your brochures neatly with your display system!

Item No	Description	Size (w x h)
5103	Single Sided Brochure Shelf	700w x 300H

Hard Plastic Transport Case

The Hard Plastic Transport Case on wheels offers you the best protection for your panel displays & the wheels also help with the transport of the system!

Item No	Description
5009	Complete Kit

Carry Bags For Panels

The easiest way to transport your Flexiframe Panel Display is in one of our carry bags! Comes complete with pocket for connectors & instructions.

Item No	Description
5001	Holds up to 8 Panels
5002	Holds up to 10 Panels
5006	Accessory Bag for Spotlights

Snapup Elegance



Snapup Elegance

A popup that doesn't look like a popup!

- Choose between flat ends or curved ends
- Add LCD Brackets
- Add built in counters
- Crossed braced structure for extra strength
- Super Slim at 190mm thick
- 10 Year Warranty

Item No	Component Description	Width	Depth
82570	Corner trims for flat ends	705mm	350mm
82577	K&H for curved ends		
82580	Semi circular table for curved systems		
82579	Media screen holder (max weight 8kgs)		
80027	iPad holder (includes 82579)		
82910	Support feet for straight systems		

Straight - Basic structures (incl. stabilizing feet)

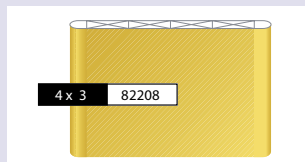

3300 (w) x 2255 (h) x 185 (d) mm

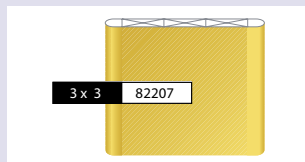

2560 (w) x 2255 (h) x 185 (d) mm

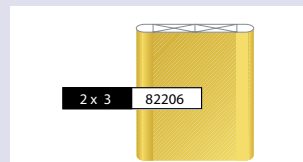

1820 (w) x 2255 (h) x 185 (d) mm

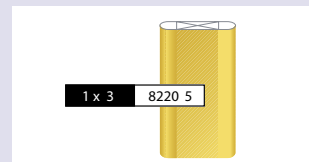

1080 (w) x 2255 (h) x 185 (d) mm

Curved - Basic structures

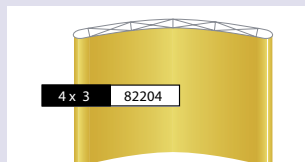

2875 (w) x 2255 (h) x 840 (d) mm

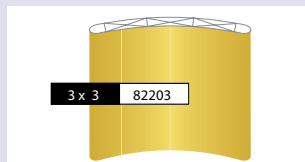

2300 (w) x 2255 (h) x 600 (d) mm

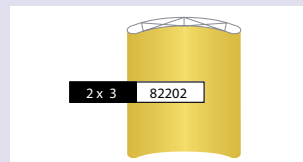

1700 (w) x 2255 (h) x 400 (d) mm

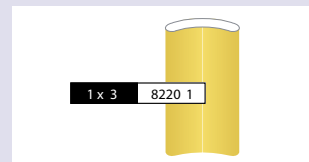

820 (w) x 2255 (h) x 200 (d) mm

Snapup Classic



Snapup Classic

The traditional & versatile popup system!

- Chose different shapes & sizes
- Join to fit different booth sizes
- Towers are also available
- Shelving can also be included
- 10 Year Warranty

MP2 Straight - Basic structures

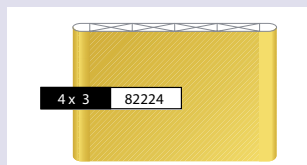

3452 (w) x 2225 (h) x 320 (d) mm

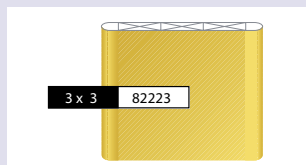

2724 (w) x 2225 (h) x 320 (d) mm

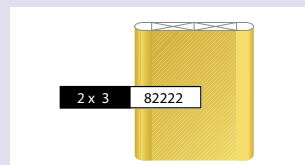

1996 (w) x 2225 (h) x 320 (d) mm

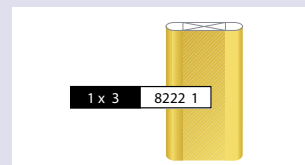

1268 (w) x 2225 (h) x 320 (d) mm

MP2 Curved - Basic structures

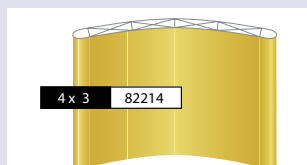

3150 (w) x 2225 (h) x 960 (d) mm

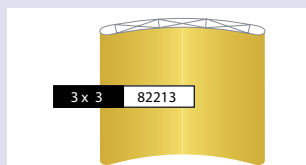

2550 (w) x 2225 (h) x 720 (d) mm

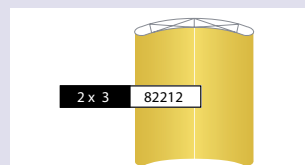

1980 (w) x 2225 (h) x 530 (d) mm

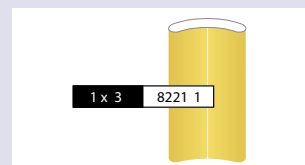

1290 (w) x 2225 (h) x 400 (d) mm

Build Your Own Snapup Kits



Build Your Own Snapup Kits

Big Wave - Basic structure

Stand out from the crowd by choosing our new SnapUp model with a "wavering" design. Perfect symmetry when used as a dividing wall with double sided graphic panels (add extra magbars). Comes in two sizes, 4x3 & 6x3.

Model	Item No	Sizes
4X3	82295	3350(w) x 2225(h) x 530(d)mm
6X3	82296	4490(w) x 2225(h) x 720(d)mm



Always Included: All SnapUp backwalls & towers include, at no surcharge, protective covers for the structure & the magbars.

Tower - Basic structures

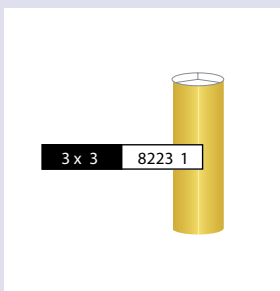

650 x 2225 (h) mm

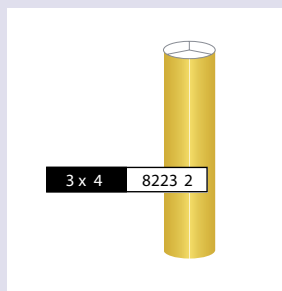

650 x 2955 (h) mm



Attachment of Graphic Panels: To be able to attach the graphic panels to the system, you must add "kickers & hangers" or "hang tabs", as well as magnetic tape.

Rite Budget Popup

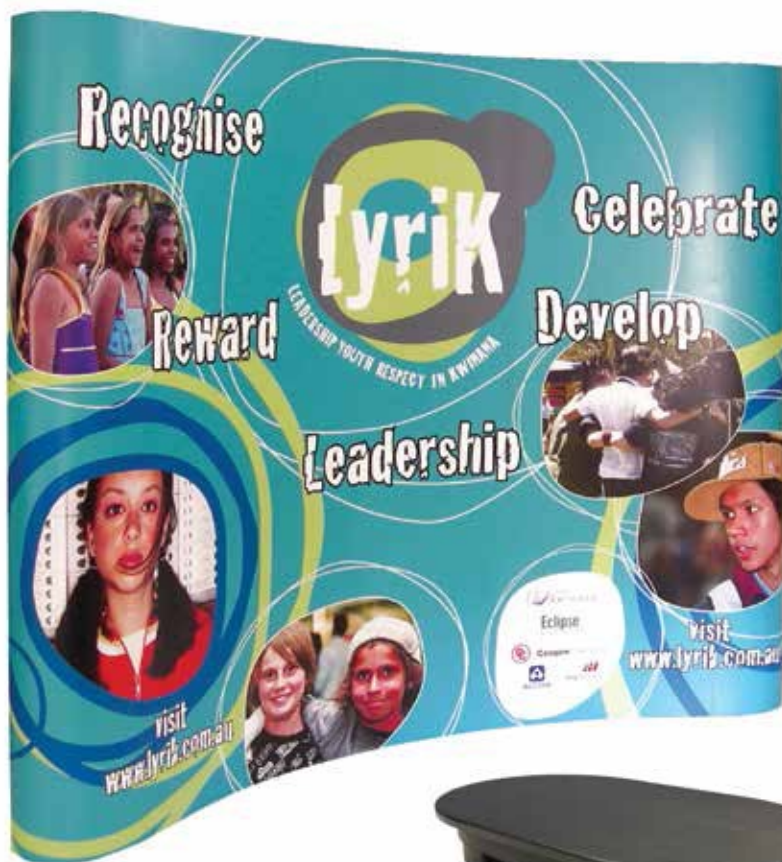

Rite Budget Popup

The Rite Budget Popup is the most economical popup available!
The popup provides a quality solution for standard Requirements.



Item No	Description	Width(mm)	Depth(mm)	Height(mm)	Packing
ET3-1020	Rite 3x3 Curved Popup	2550	720	2225	1 Per Box
ET3-1021	Rite 4x3 Curved Popup	3150	960	2225	1 Per Box
ET3-1020HC	All In One Case	700	500	1000	1 Per Box
ET3-1020HCWT	Wooden Top For Case				1 Per Box
ET3-1020SL	Halogen Budget Spotlight				2 Per Box
ET3-1025	Led Budget Spotlight				1 Per Box

Mark Bric Snap Up Stretch



Mark Bric Snap Up Stretch

Our newest SnapUp addition offers the quickest & easiest way to set up & display a seamless large format Graphic print. Ideal to use at short term events & exhibitions when time is a decisive factor.

i The SnapUp stretch is available in a straight format & in 3 different sizes. You can choose to have the fabric covering ends or just use the front side as your display area. The printed fabric remains attached to the system also during take-down & storage in the protective carrying bag or case.

i **Flexibility:** The graphic image is printed on a stretch Fabric material & then attached to the system with velcro tape. In erecting the system, the fabric is automatically stretched out & a smooth surface is achieved.



Item No	Description	Width(mm)	Depth(mm)	Height(mm)	Packing	Warranty
82218	SnapUp stretch 2x3 structure (including carry bag on wheels)	1525	345	2260	1 Per Box	10 Years
82219	SnapUp stretch 3x3 structure (including carry bag on wheels)	2260	345	2260	1 Per Box	10 Years
82220	SnapUp stretch 4x3 structure (including carry bag on wheels)	3000	345	2260	1 Per Box	10 Years

All-In-One Case



Budget Case



Multi-Compartment Case



All-In-One Case

Our newest case model with a very elegant design & practical grip handles all around for easy handling & lifting of the case.



Unique feature: The case is equipped with metal bands to be able to attach the wrap-around graphics with magnetic tape. Advantage: Very quick & easy assembly of panel & a perfect stretch!!

Desk/.Counter	Wooden Top
ET3-1020HC	ET3-1020HCWT

Multi-Compartment Case

The case has three well-protected compartments: one for the structure, one for the graphic panels & one (the lid) for two spotlights.



The case can be divided into three parts to facilitate handling & lifting. The lid may also be used as a step when assembling the spotlights on the system

Desk/.Counter	Wooden Top
5040	5216

Budget Case

Save money & choose our budget case solution. Our most compact & lightweight case.

Desk/.Counter	Wooden Top
5039	5222

Build Your Own Snapup Kits



Inner shelving for MP2 systems



With the use of the L profiles you can change the curved SnapUp ends into flat SnapUp ends



Carrying bags



LED spotlight



Spotlight (Item no. 80021)



Velcro panels

Build Your Own Snapup Kits

Inner shelving for MP2 systems

Straight	Curved Inner	Curved Outer
5229	5227	5228



3 Sided Magbar (Item no: 82930)

For mounting of side graphics in shelf opening.



Wooden Shelf for MP2

Including Carrying Bag

Velcro Panels

The SnapUp MP1 & MP2 systems can be equipped with velcro panels (fabric panels). Single or double sided, as well as partly in combination with graphic panels. Velcro panels act as an attractive & neutral background at exhibitions. They are also ideal for attaching messages, posters, prints etc. by using our special velcro tape.

Please note: We also offer rolls of velcro panel with backing for customising & local cutting. Contact us for more information & see price list.

Item No	Description
80361	MP1 Centre Front Panel
80362	MP1 Reverse Panel
80363	MP1 End Panel
80364	MP2 Curved Centre Front
80365	MP2 Curved Reverse Panel
80366	MP2 Straight Centre Front/Reverse
80367	MP2 End Panel
80901	Velcro Tape, 1 Roll = 25 Metres

Carrying Bags

Soft padded bags with shoulder strap for transportation of structure & graphic panels.

- Padded Carrying Bag for the graphic panels item no. 5046
- Padded Carrying Bag for the structure item no. 5045

Custom Design Snapup Kits

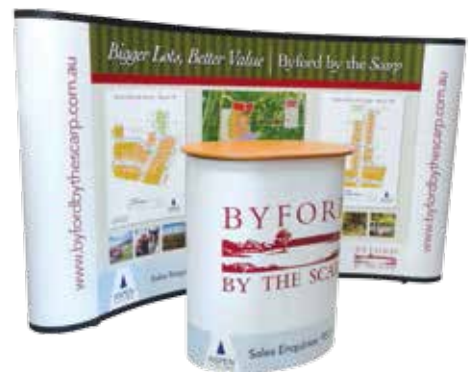

Mark Bric Mp2 Mini Counter



Rite Expo Reception Desk



Mark Bric Mp2 Mini Counter

A counter solution that will display your brochures & small products in style!



A carry bag for the mini counter is always included. This bag will also have room for the graphics, when using 3 separate panels. Should you instead want to use one larger single panel, you will need to add one graphics bag for the transportation of this larger graphic.



Carry bag for mini counter & graphic bag for large single graphic panel



Carry bag for mini counter & 3 graphic panels

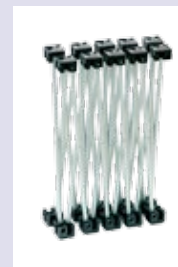

Both systems fold down completely in to a carry bag



Mini counters come with wooden shelves

Item No	Description	Width(mm)	Depth(mm)	Height(mm)	Weight	Packing	Warranty
82038	Mini Counter	685	295	1035	10KGS	1 Per Box	10 Years
5035	Extra graphic bag	1200	150	150			

Magnetic tape for one graphic panel is included in all deliveries of the counters.

Rite Expo Reception Desk

The rite expo reception desk is a great economical reception desks for all your exhibition & display requirements. This desk has a black top to make your presentation even better! All carry bags are included.

Item No	Width(mm)	Depth(mm)	Height(mm)	Weight	Packing
ET3-1031	1200	370	960	10KGS	1 Per Box



Mark Bric Mp2 Reception Desks



Top & inner shelves in timber



Mark Bric Mp2 Reception Desks

Receive your customers in style at the next trade show event & exhibition. The mark bric reception desks offer extra ordinary stability & plenty of inner shelving space. The wooden table tops & shelves give the units a high class appearance - top quality in all details.

Flexibility: The graphic panel is easily wrapped around the units.



Black tops are available



Carry bag on wheels

item No	Description	Width(mm)	Depth(mm)	Height(mm)	Weight	Packing	Warranty
82238	Midi Reception Desk	1240	460	905	18KGS	1 Per Box	10 Years
82240	Maxi Reception Desk	1410	580	895	23KGS	1 Per Box	10 Years

Magnetic tape for one graphic panel is included in all deliveries of the counters.

Rite Sampling Table



Expo Case



Rite Sampling Table

item No	Description	Width(mm)
ET3-1100	Rite Sampling Counter	800mmW x 400mmD x 2080mmH

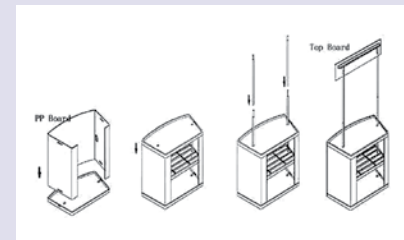

Expo Case

An extremely durable and shock-proof case with quality locks and wheels. Easy and quick to unfold and with top stability when used as a large size counter. 1 hard case on wheels

- 1 fold-out wooden counter top in black matte finish
- 4 wooden inner shelves in black matte finish
- 1 kick plate
- 4 velcro strip fasteners
- 1 soft case for the counter top
- 1 soft case for the inner shelves
- 1 tube for the wrap around graphic



item No	Description	Width(mm)	Depth(mm)	Height(mm)	Weight	Packing	Warranty
10604	Expo Case	1245	600	965	19,5kgs	1 Per Box	10 Years

Mark Bric Ego Exhibit

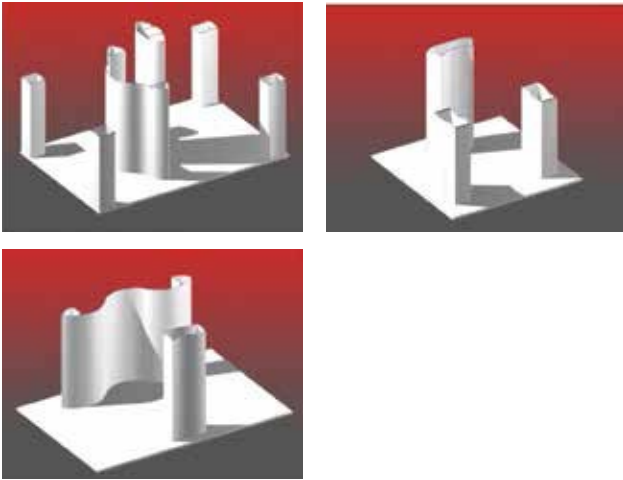

MARK BRIC EGO
 Building on a bright idea™



Mark Bric Ego Exhibit

Introducing Mark Bric EGO - a revolutionary concept within displays & exhibition building. Ego gives wings to a bright new idea of having a distinctive graphic panel system with room for much more creativity & customised designs, compared to more limited stand building & pop-up systems. The construction virtually disappears in favour of the printed graphics, your message - visual communication at its best.

The new concept is delivered as a highly engineered, yet extremely simple building system using only three basic components. Ego can be assembled in virtually any size & shape configuration, with the structural integrity for mounting heavy accessory items such as LCDs, product showcases, & load bearing shelves. To keep things simple, Ego even provides completely tool-free assembly.



Mark Bric Ego Exhibit Customisation Options

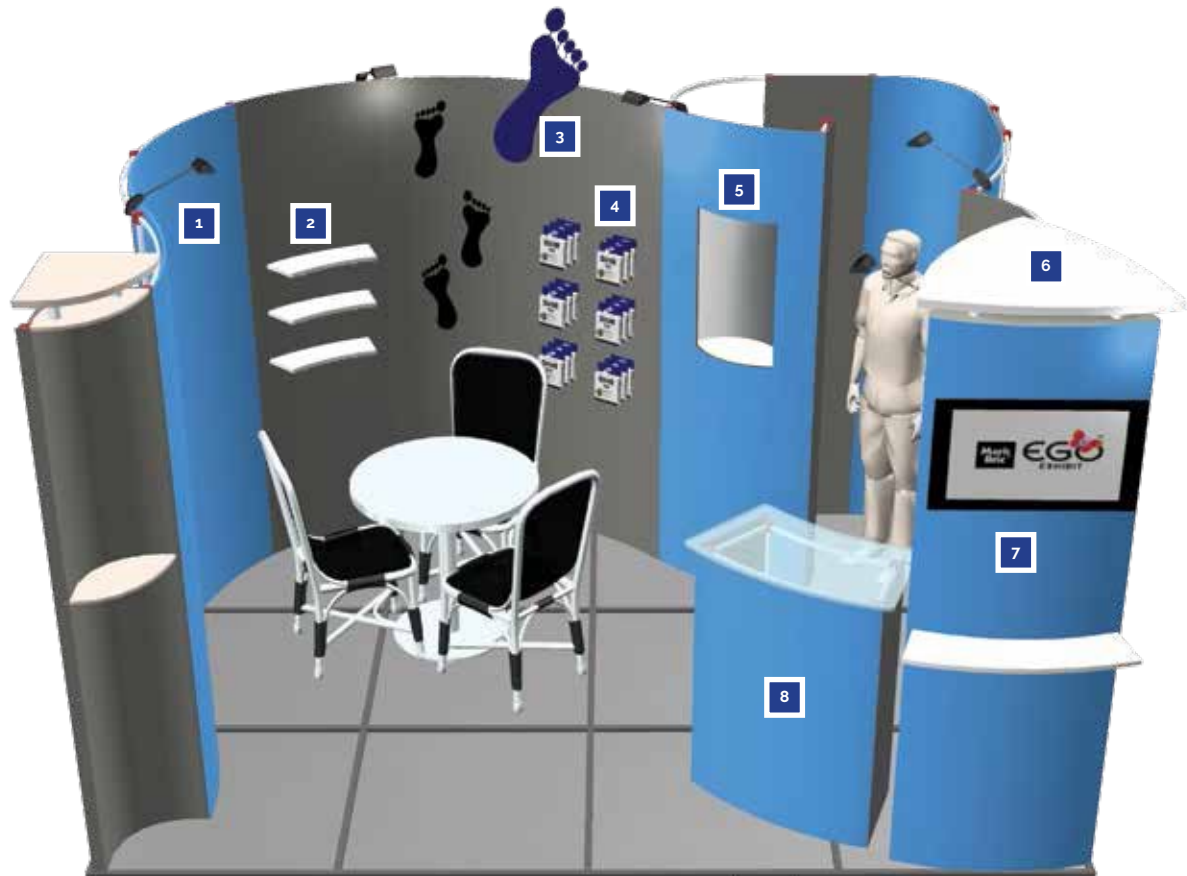

Mark Bric Ego Exhibit Customisation Options

Further customise your stand by adding a number of the attractive & functional ego accessories

- | | | | |
|---|---------------|---|------------|
| 1 | Spotlights | 5 | Show cases |
| 2 | Shelving | 6 | Tower tops |
| 3 | Customised 3D | 7 | LCD |
| 4 | Hooks | 8 | Counters |



EGO Customisation: EGO is extremely compact during transport & storage. All six trade show stands are delivered in custom-made rolling shipping cases with compartments for the different components.

Mark Bric Ego Exhibit Desks



Mark Bric Ego Exhibit Towers



Mark Bric Ego Exhibit



Mark Bric ISOframe®

ISOframe Wave™

ISOframe Wave is ideal for small & medium sized exhibit areas & will adapt to any size of stand. Choose Wave for maximum flexibility & simplicity. Wave is sold in kit form (Starters & Extensions).

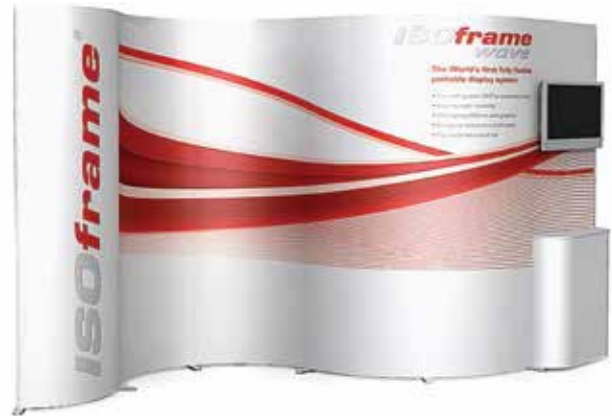

ISOframe Compact™

ISOframe Compact brings in more architectural features & a more rigid beam construction. Choose Compact for maximum in design & stability. Compact is sold in kit form (Starters & Extensions).

ISOframe Exhibit™

ISOframe Exhibit is ideal for larger exhibit areas where a more advanced construction is needed. Choose Exhibit for maximum in versatility & size. Exhibit is sold in component form.



Mark Bric ISOframe®

For large custom modular stands or for self-build portable systems, the new & unique Mark Bric ISOframe exhibition system is the intelligent choice. The ISOframe structure can be assembled quickly, thanks to the tool-free FASTclamp connector, & can be clad in any number of rigid, semi-rigid or flexible graphic panels. No specialist trades are required during set-up. This coupled with reduced storage & transportation costs, not to mention the re-usability of the system, means exhibiting becomes a lot more cost effective with ISOframe. Read more – www.isoframe.com

Fully interchangeable: ISOframe is “one” system! Framework sections of the different models (Wave, Compact & Exhibit) can be combined into hybrid systems & the graphic panels (standardised at 400 mm/15.75” & 800 mm/31.5”) between the models can be interchanged as well.

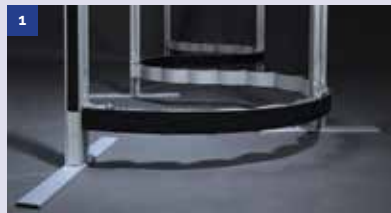

The flexible Wave link is a strong aluminium structure which enables you to instantly shape your display as desired. Reshape the link as needed, from straight to halfcircle, in either direction.

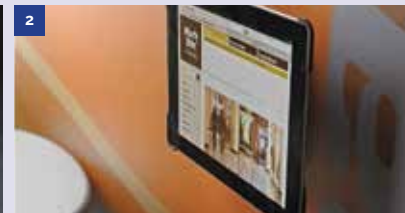

A full range of useful ISOframe accessories is available & can be easily attached to the system – holders for monitors & Pads, spotlights, literature holders etc.



The design of ISOframe delivers the utmost in functionality, attractive looks, quality finish & close attention to the smallest detail.



All ISOframe models incorporate our patented & tool-free FASTclamp connector – no more struggle with nuts & bolts used on other systems.

ISOframe Exhibit™



Extremely cost effective. No specialist trades are required during set-up. This coupled with reduced storage & transportation costs, not to mention the re-usability of the system, means exhibiting becomes a lot more cost effective with ISOframe.

- 1 Media screen
- 2 Storage room
- 3 Lockable door



ISOframe Exhibit™

ISOframe Exhibit is the ideal system for designing & building customized large format exhibition stands. It uses fixed horizontal beams (available in 9 different shapes), instead of the flexible Wave link, to give the system the rigidity & stability needed for more advanced large size constructions (up to 5 meter / 16 ft. height). Our unique tool-less FASTclamp connector & easy to use self aligning graphics let you create these stunning exhibition stands both easily & cost effectively.



Ideal for customized stands

ISOframe Exhibit is extremely versatile to fulfil a large variety of different design needs & shapes. Special 3D-design software is available for our worldwide distributors & dealers to create attractive & functional stands.



Sold in component form

ISOframe Exhibit uses fixed horizontal beams in different shapes: 5°, 10°, 15°, 22.5°, 30°, 45°, 60°, 90° & straight, as well as vertical posts in different lengths to create the desired design & height of the stand.



Use single- or double sided

An Exhibit wall looks fantastic when clad with graphic panels on both sides. The unit is extremely slim (40 mm / 1.5") & the aluminium corner trims further enhance the impression.



PRICING

Email us for a complete component list or email your ideas for pricing

ISOframe Wave™



ISOframe Wave™

The World's first fully flexible portable display system. Stunning looks, infinite flexibility & extremely user-friendly – ISOframe Wave is the first portable display system combining the best of all worlds. Flex the entire exhibit wall into the shape you need at each venue, extend or reduce as required. All thanks to the unique Flexi-Wave link connector which connects every vertical post in the system. ISOframe Wave is ideal for small & medium sized exhibit areas where total flexibility is paramount.



ISOframe Wave – The Shapeshifter™

The ISOframe Wave system is extremely compact during transport. A selection of bags & cases for the structure & the graphic panels are available.



- 1 Media screen
- 2 Self-aligning 800 mm (31.5") wide graphics
- 3 Keyboard table attachment
- 4 Three standard heights:
Mini 209 cm (80.1"),
Midi 229 cm (88.6") &
Maxi 249 cm (96.5")



ISOframe Wave™

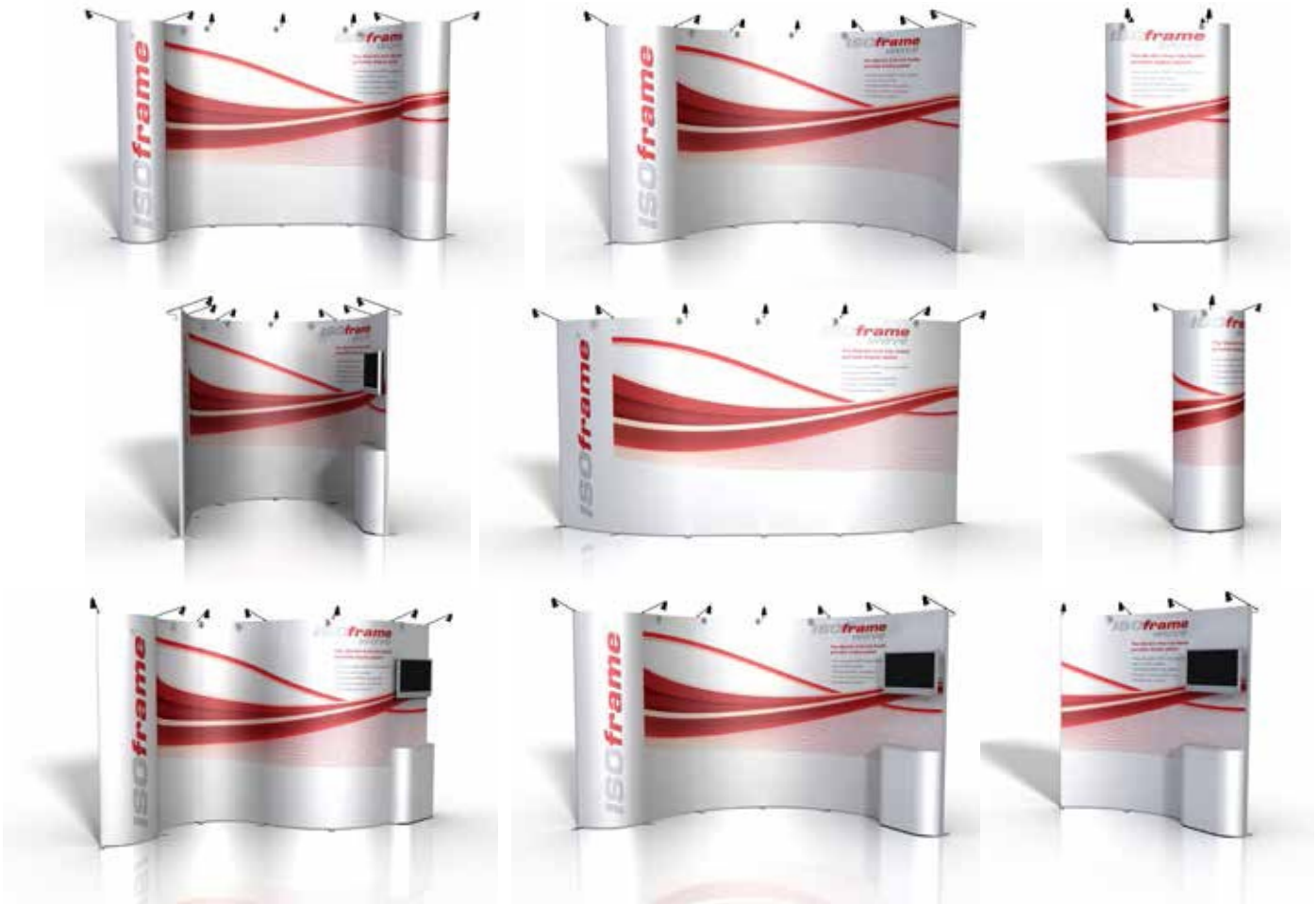

Shape your display as desired

Alternative layouts created using the same (or fewer) graphics & framework as the 6-section display shown on opposite page.



ADVANTAGES

Email us to find out the advantages of becoming a preferred isoframe dealer



The patented Flexi-wave link

The wave link can flex up to 180 degrees each way in the horizontal position, yet the structure remains unbelievably strong & stable.

Easy mounting in a few steps



ISOframe Components

ISOframe WAVE Structure

- 1** Wave Midi Starter Kit - Starter Panel
- 2** Wave Midi Extension Kit - Adds Panels To The Starter

Item No	Description	Height	Width	Weight
IS-W-82-S	Wave Midi Starter Kit - Starter Panel	2270mm	800mm	6.2KG
IS-W-82-E	Wave Midi Extension Kit - Adds Panels To The Starter	2270mm	800mm	2.7KG
IS-800-KHN	800mm Kicker & Hanger			



Accessories



Media Screen Holder 75/100 - Small

Media Screen Holder 400/200 - Large

Item No	Description
IS-80-TM03	Media Screen Holder Vesa 75/100 - Small
IS-80-TM04	Media Screen Holder Vesa 400/200 - Large
15-80-TM05	iPad Holder
IS-80-LH01	Literature Holder
IS-SL-LED	Led Spotlight



iPad Holder



Literature Holder

Bags



Padded Bag on Wheels



Small Graphic Tube - Attaches To Padded Bag



Large Graphic Tube

Item No	Description	Size
IS-TC-01-MB	Padded Bag On Wheels	Max 6 Section
IS-0850-RTS-S-MB	Small Graphic Tube - Attaches To Padded Bag	850mmH x 250mmD
IS-0850-RTB-S-MB	Large Graphic Tube	850mmH x 250mmD
ET3-1055	Extra Large Graphic Tube	1050mmH x 250mmD

ISOframe Components

Standalone Counters

Item No	Description	Height	Width	Depth	Weight
IS-FT02	Rectangular Counter	890mm	900mm	400mm	14,7KG
IS-FT03	Circular Counter	890mm	650mm	650mm	13,9KG



Built-In Counters



Semi-Circular Square 90 Degree Corner Keyboard Semi-Circular

Item No	Description	Height	Width	Depth	Weight
IS-80-TA01-N	Square Table Attachment	910mm	800mm	500mm	15,9KG
IS-80-TA02-N	Semi-Circular Table Attachment	910mm	800mm	400mm	12,8KG
IS-80-TA03-N	Keyboard Table Attachment	910mm	800mm	200mm	9,7KG
IS-80-TA04-N	90Deg Corner Table Attachment	910mm	720mm	310mm	8,8KG

Plinths



Item No	Description
IS-CO-KP	Keyboard Plinth For Oval Post
IS-CO-ST	Table Plinth For Oval Post

Doors



Item No	Description
IS-DOOR	Straight Door With Lock

Slatwall



Single Height Slatwall Showcase



Double Height Slatwall Showcase

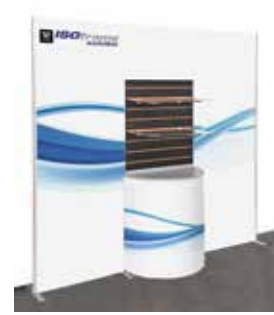

Slatwall Panel

Item No	Description	Height	Width	Depth
IS-SW-22-02	Single Height Slatwall Showcase	760mm	755mm	400mm
IS-SW-26-02	Double Height Slatwall Showcase	1645mm	755mm	400mm
IS-SW-02	Slatwall Panel	845mm	800mm	

ISOframe Ideas





ISOframe Counter & Shelf Systems



ISOframe – Large Reception Counters

The Mark Bric ISOframe program now includes a modular system of large reception counters, which can be individually designed to fit any reception area or trade show stand. Choose one of our complete counter units – straight or curved - with wooden top & inner shelves in black finish, or customize your counter by combining different counter sections into a unique shape. All of our reception counters offer a stylish solution at a reasonable price, with no compromise on quality.

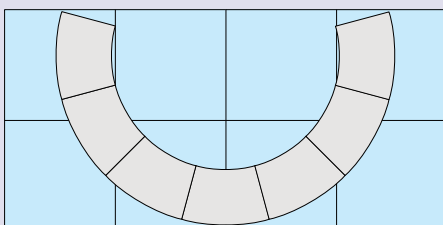

A curved 7-section customized counter unit.
Approx. size: 3m (w) x 2m (d) / 118" (w) x 78" (d)



FASTclamp

The ISOframe counters have an easy & tool-free assembly thanks to our unique & patented FASTclamp connector.



Useful inner shelving

The standard counter units include 1 inner shelf for each section. More shelves can be added & purchased extra.



Double sided graphics

The counter units can be prepared & delivered for using graphic panels on both sides. Please state when placing the order.



Carrying bags & graphic cases are available.

Easy mounting in a few steps



Standard units

3-, 4- & 5-section counter units (straight or 30-degree curve) serve as our standard units. Delivered complete with framework, top shelves & 1 inner shelf/section.



A straight 3-section standard counter unit. Approx. size: 2,5m (w) x 0,5m (d) / 98" (w) x 20" (d)



A curved 5-section standard counter unit. Approx. size: 3m (w) x 1,4m (d) / 118" (w) x 55" (d)

Customized units

Combine curved & straight sections to build your own unique reception counter. 12 curved sections make a full circle.

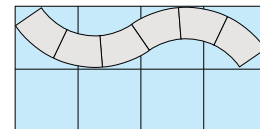

An S-curved 6-section customized counter unit. Approx. size: 4,1m (w) x 1m (d) / 161" (w) x 39" (d)

ISOframe – Shelving System

A new & smart system for attaching shelves to the ISOframe backwalls & trade show stands. Choose number of shelves & their position in line with your needs & requirements. One more useful addition to the highly versatile ISOframe system.



The wooden shelves are in an attractive black finish & available in a straight or 22,5° curved shape.

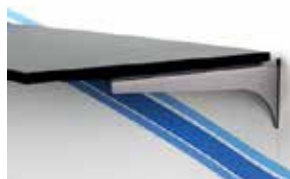

Shelf holders (brackets) are equipped with pre-mounted velcro tape for holding the shelves in place. Screws can be added for a fixed mounting.

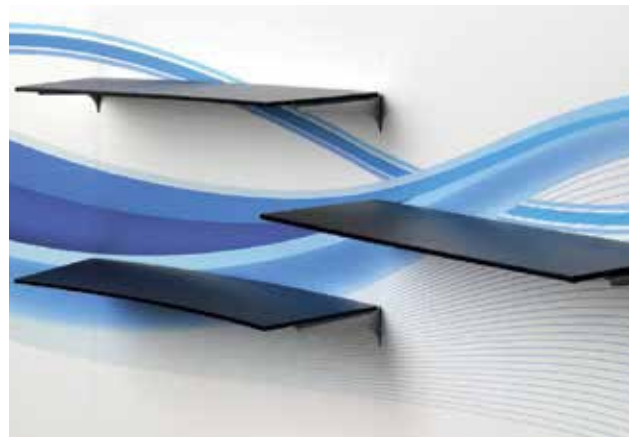

Please note: Free-standing wall units may need an extra support for securing stability. Please contact us for our recommendations.

ISOframe Fabric System



ISOframe® – Fabric

Ideal for shell scheme or freestanding stands, our silicone-edged tension fabric system is extremely portable & with our unique FASTclamp connector, gives a tool-free assembly, making it 15 times faster to build than conventional tension fabric frameworks.

- Exclusive frame clamp creates perfect mitred corners & is 15 times faster to construct than rival fabric products
- Tool-less assembly
- Continuous, unrestricted fabric graphics
- Extremely portable, lightweight graphics
- Easy for the self-build market, both freestanding & shell clad



Mounting fabric

The silicone edge simply glides into the channel.

Easy mounting in a few steps



Insert angle brackets into the profile.



Snap the FASTclamp closed to secure.



Repeat with the second profile.



A secure connection without any tools!

ISOframe Fabric System – Ideas



Texstruct

Double Sided



Double sided
- Hanging

Double sided
- Freestanding



Double sided connection

Single Sided



Single sided wall profile



Support bar



Slimline wall profile

Texstruct

Texstruct is an extremely cost effective fabric exhibition and retail display system. It is available in both single sided and double sided along with a range of different connectors to create the shape and solution you need!

Single Sided

Key Features:

- Available in Slimline and heavy duty versions
- Great for fastening direct to walls or hanging.
- Packed flat – Easy transport
- Interchangeable tensioned fabric graphic
- Install made easy

Texstruct Double Sided

Key Features:

- Great for freestanding displays
- Create double sided walls and hanging displays
- Packed flat – Easy transport
- Interchangeable tensioned fabric graphic
- Easy Installation
- Top of Form

Item Code	Description
ET3-210	Heavy Duty Single Sided – 5M Length
ET3-212	Super Slim Single Sided – 5M Length
ET3-214	Heavy Duty Double Sided – 5M Length
ET3-216	Supporting Bar – for Heavy Duty
ET3-220	Corner Connector – for Heavy Duty
ET3-221	180° Connector – for Heavy Duty
ET3-222	90° Connector – for Slimline
ET3-225	A Foot Base
ET3-226	Flat Foot Base
ET3-227	Curve Foot Base
ET3-228	"T" Connector – for Heavy Duty
ET3-200	Silicone Tape – 12mm x 3mm



Flexiframe	78-80
Freestanding Poster Displays	80-81
Visirite	82-91
Snapframes	92-93
Wall Displays	94-95
Sign fixings	96-101
Freestanding Sign holders	102
Pavement Signs	103 -113
Flute holders	114-116
Road Sign holders	117-120

POSTER & SIGNAGE SYSTEMS

Mark Bric Flexiframe



Mark Bric Flexiframe

Mark Bric Flexiframe is a unique framing system to present your graphic images in the neatest way. Flexiframes Allow you to either hang them from the ceiling or fix them to the wall. They also can be freestanding when used With stand components on the following pages.



Flexiframe Details: The standard frames are delivered with a top opening on the short side. if you prefer a different opening or a fully closed frame please specify when ordering. All Sizes are insert panel size Outer frame size - panel size + 28mm Visible panel Size - panel size minus 20mm thickness of insert is a max of 5.5mm



Item No	Size(mm)	Warranty
101	700 x 1000	5 YEAR
103	500 x 700	5 YEAR
104	600 x 500	5 YEAR
105	700 x 300	5 YEAR
106	500 x 200	5 YEAR
108	A1(594 x 841)	5 YEAR
109	A2(420 x 594)	5 YEAR
110	A3(297 x 420)	5 YEAR
111	A4 (210 x 297)	5 YEAR

Frame Components

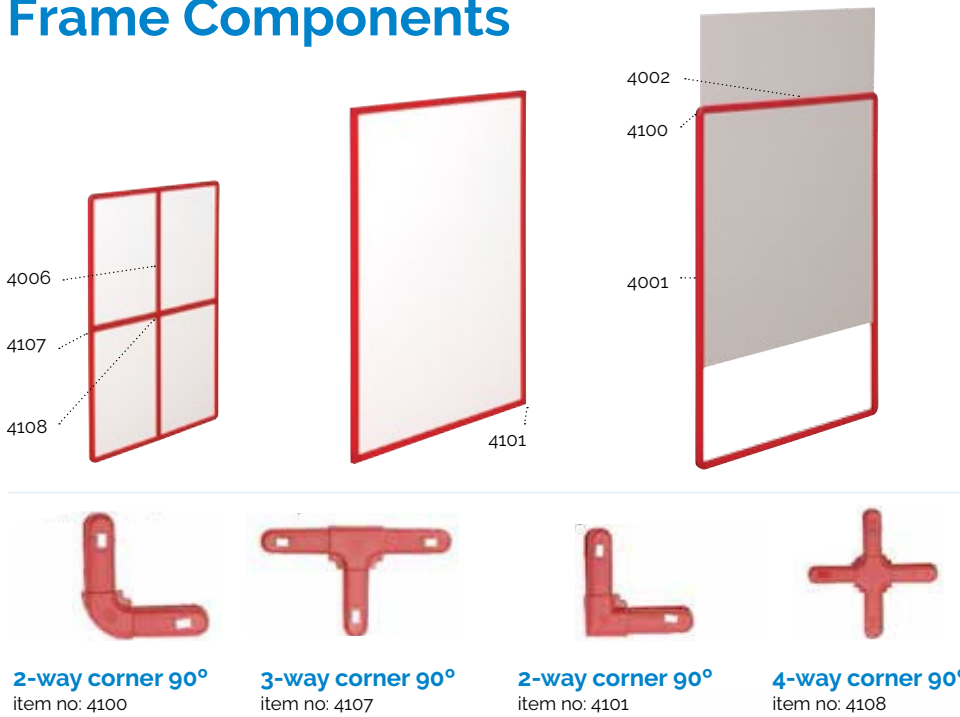

Profiles - standard colours

Length of profile 238cm.

Each box contains profiles in the same colour.

Profile	Item	Packing
Solid	4001	20pcs
Split	4002	20pcs
Double	4006	15pcs

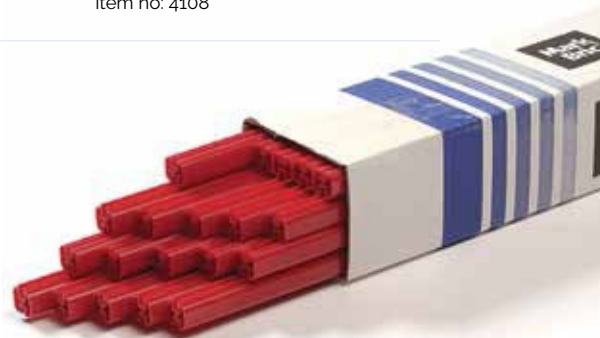

Mounting & Suspension Of Single Frames

Wall Bracket
Item no: 2000
For quick mounting of frames



Wall Bracket
Item no: 2001
For fixed mounting of frames



Ceiling Connectors
Triangle Connector - item no: 3040
Square Connector - item no: 3041
These brackets form square triangular modules which can be hung from a ceiling



C-Hooks
Item no: 2005
C-Hooks connect frame to hanging accessories



Chain
Item no: 2006
A way of suspending your frame with extra class



Frame Components

* Purchase frames separately

The Extendable Floorstand with Wire Base

Item no: 2400

For frames:
297mm - 700mm Wide
300mm - 1180mm High



The Prestige

item no: 2405

For frame A1
item no: 2406

For frame:
500 x 700mm

Chrome plated support
with anthracite (g1) base



The Flex-stand

Item no: 2436

For frames:
500 - 760mm Wide
600 - 1500mm High
Black or Silver



Swing Wing Unit

Support Bracket

For swing wing units, item 2013 & 2014 used with frames larger than A3, we strongly recommend the use of our new support brackets (length 29cm).

Description	Item
For max. 5 frames	2013
For max. 10 frames	2014
Support Bracket	2015



Purchase frames separately for all items on this page.

Flexiframe - Floor Stands

* Purchase frames separately

Arched Feet

Item No	Height Excl Frame	Colour
2306	150mm	Chrome



Support Feet

Item No	Height	Colour
2300	110mm	Chrome



Flexiframe - Table Stands

* Purchase frames separately

Frame Support



Flexiframe - The versatile, consistent promotional image

Item No	Colour
2203	Chrome

* Max frame size is A3.



Rite Entrance Poster Display



Rite Pedestal Snapframes



Rite Entrance Poster Display

The Entrance poster display is perfect for retail stores, cafes, bars, showrooms and Shopping centres.

- Available in 5 sizes
- Large stable base with additional weight
- Coated a classy Chrome colour
- 2 Clear protecting plastic coverings supplied for posters
- Can take up to a 5mm thick board

ITEM NO	DESCRIPTION	COLOUR
ET4-120	Rite Entrance Poster Display A4 Size	Chrome
ET4-121	Rite Entrance Poster Display A3 Size	Chrome
ET4-122	Rite Entrance Poster Display A2 Size	Chrome
ET4-123	Rite Entrance Poster Display A1 Size	Chrome
ET4-124	Rite Entrance Poster Display 750 X 1000M	Chrome

Rite Pedestal Snapframes



Item No	Size
ET4-60	A4 Landscape/Portrait
ET4-63	A3 Landscape/Portrait

Visirite



The possibilities are endless for Visirite!
Got a signage project? Use Visirite.



ADVANTAGES

1. 1 System = 1000's of solutions
2. Easy handling & assembly
3. No high cost equipment
4. Low labour costs

Visirite

The Visirite concept was developed out of the need for a solution to replace the practice of tying banners placed between two star pickets which take but a gust of wind to turn from a company advertiser to a company deterrent. Visirite fits perfectly over star pickets and keeps those banners looking excellent! This initial concept has grown into a much larger range of signage solutions so much so that it can now meet all of the sign writers needs, take care of all substrates and perfect for all sizes

- Real estate
- Balustrade
- Café Barriers
- Information Boards
- Directional Boards
- Fencing

Applications

Hard / Rigid Substrates

- Flute Sheet
- Holds up to 5mm

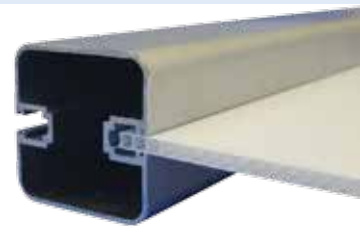

Hard / Rigid Substrates

- Aluminium Composite Panel
- Holds up to 5mm



Banner material

- Takes keder to hold the banner material.
- Takes both Rigid Keder (ET6-120) & Silicone Keder (ET6-125)

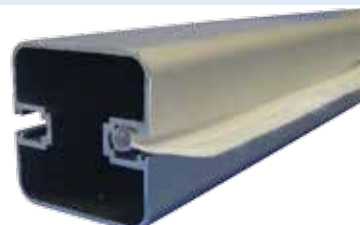

Visitrite Aluminium Extrusion

- Available in Anodised, mill, black finish and Pearl white
- Heavy duty
- Excellent for long term applications
- Fits all components
- Length – 5000mm
- Dimensions – 55mm x 55mm x 1.6mm
- Can be powder coated different colours



Item No	Description	Size
ET4-3005	Anodised Aluminium	55 x 55 x 1.6mm x 5m
ET4-3006	Satin Black	55 x 55 x 1.6mm x 5m
ET4-3007	Mill finish	55 X 55 X 1.6mm x 5m
ET4-3008	Pearl White	55 X 55 X 1.6mm x 5m

New Visitrite Mini

- Available in Anodised, Mill finish, Satin Black, Pearl White
- Perfect for smaller sign frames and hanging rails
- Interconnects with standard Visitrite
- Can be supplied in other colours
- Length is 5000mm



Item No	Description	Size
ET4-3001	Anodised Aluminium	35 x 16mm x 5m
ET4-3002	Satin Black	35 x 16mm x 5m
ET4-3003	Mill Finish	35 x 16mm x 5m
ET4-3004	Pearl white	35 x 16mm x 5m

Visirite Flat Foot



Hard Surface Mount

- Mount horizontally on walls for banners & other signs
- Mount vertically for signs freestanding on concrete
- Plate dimension is 200 x 200mm
- Mounting profile is 250mm H

Item No	Description
ET4-3080	Hard Surface Mount

90° Connector

- Fits all 3 extrusions
- Create mitre & T junctions

Cutting Extrusion for this corner:
- Minus 30mm for insert size

Item No	Description
ET4-3085	90° Aluminium Connector
ET4-3086	90° Heavy Duty Metal Connector

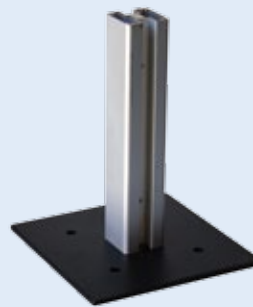

Visirite Flat Foot

- Perfect for café barriers and freestanding signs
- Connects into all standard Visirite
- 400mm x 65mm x 10mm

Item No	Description
ET4-3081	Visirite Flat foot

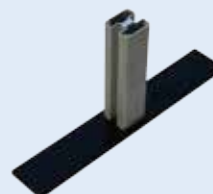

Visirite Flat Foot

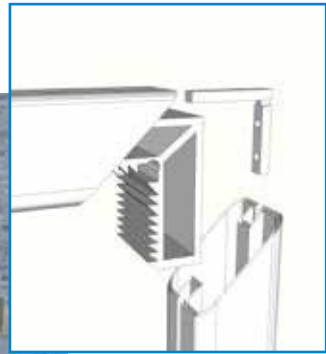

2 Star Pickets

- Fits perfectly for short term signs
- 1800mm Length

Item No	Description
ET4-3079	Star Picket



3 90° Connector

- Fits all 3 extrusions
- Create mitre & T junctions

Cutting Extrusion for this corner:
- Minus 30mm for insert size

Item No	Description
ET4-3085	90° Aluminium Connector
ET4-3086	90° Heavy Duty Metal Connector



Quick Corner – Visirite

- Use in conjunction with Heavy duty connector or screw into place
- Reinforce the corner for greater strength.

Item No	Description
ET4-3084	Quick Corner



Quick corner 1



Quick corner



Wall Mount

- For banner frames on walls
- Bracket Width – 50mm

Item No	Description
ET4-3070	Wall Mount

90° Connector

- Fits all 3 extrusions
- Create mitre & T junctions

Cutting Extrusion for this corner:
- Minus 30mm for insert size

Item No	Description
ET4-3085	90° Aluminium Connector
ET4-3086	90° Heavy Duty Metal Connector



Visirite Rubber Seal

- Ideal for 2mm and thinner substrates
- Stops movement in the track
- Does take 3mm also

Item No	Description
ET4-3100	Visirite Rubber Seal – Per Metre





90° Plastic Moulded Corner

- Easy assembly
- Safe, no sharp edges

Cutting extrusion for this corner:
 - Minus 40mm for insert size
 - Minus 10mm for visual size

Item No	Description
ET4-3050	90° Plastic Moulded Corner



3Way Plastic Moulded Junction

- Easy to assemble
- Fits all 3 extrusions
- Safe, No sharp edges

Cutting extrusion for this corner:
 - Minus 40mm for insert size
 - Minus 10mm for visual size

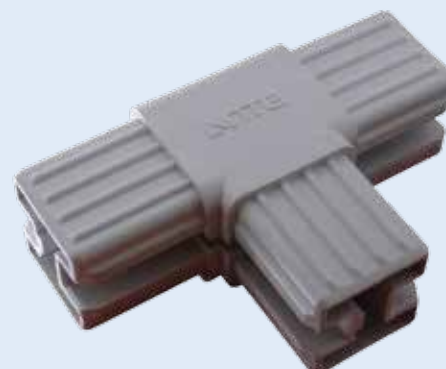

Visirite Frame Combinations

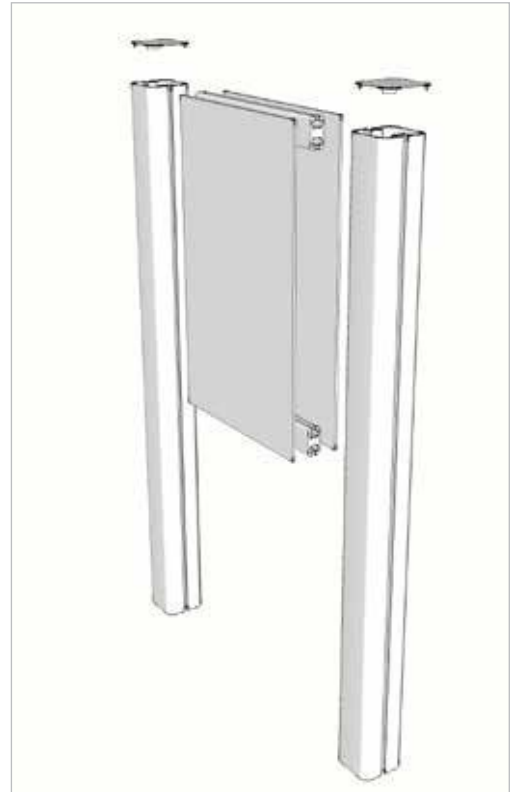
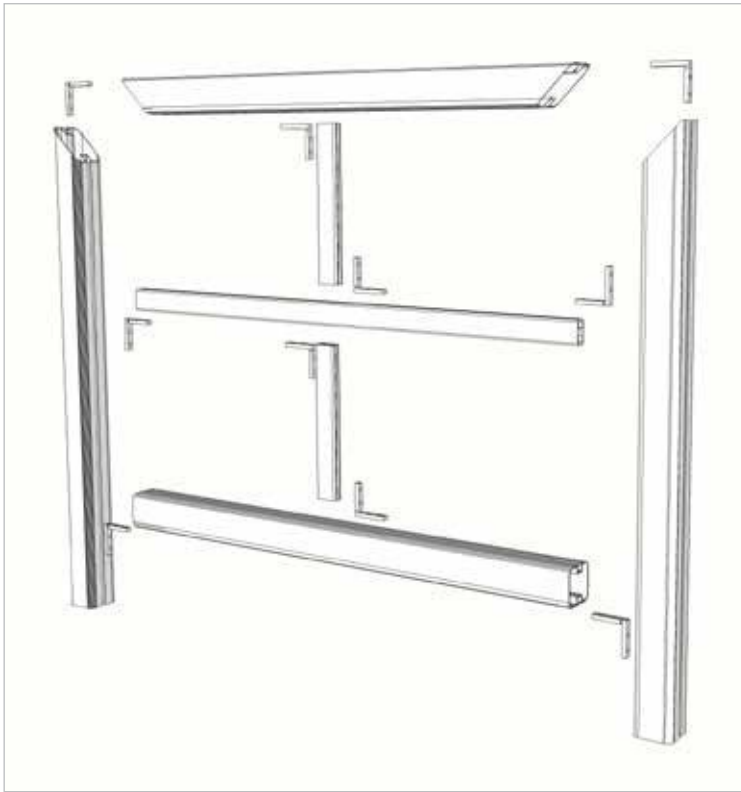

Visirite Frame Combinations

Using a combination of Standard Visirite Extrusion & Mini Visirite extrusion you can create Large sign frames.

Size does depend on the location of the sign.

Combining standard visirite and mini visirite also allows you to create frames that are insert. These are perfect for real estate signs and other prestige sign requirements.



Other Visirite Accessories

Mounting Profile

- Concrete into ground, extrusion sleeves over it
- 3000mm Length



Item No	Description
ET4-3075	Mounting Profile

Plastic End Cap

- For hanging banners
- Vertical sign posts

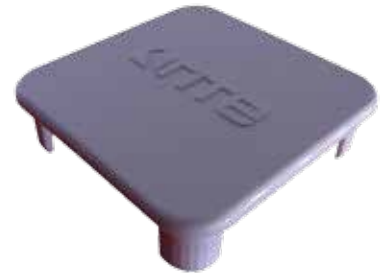

Item No	Description
ET4-3065	Plastic End Cap

Hanger & Banner Support Clip

- For hanging banners
- For signs with frames
- Hole diameter – 10mm



Item No	Description
ET4-3060	Hanger & Banner Support Clip

Fixing Screw

- Fits between profile

Item No	Description
ET4-3059	Fixing Screw



Screw Driver

- For electric drill

Item No	Description
ET4-3058	Screw Driver



Allen Key

- For mitre junction

Item No	Description
ET4-3087	Allen Key



90 Degree Bracket

- Connect frames
- Create free standing 4 sided towers
- Mount frames to walls



Item No	Description
ET4-3088	90 DEGREE BRACKET INC BOLTS

Visirite for Banners



Demonstrate the advantages of Visirite with the Visirite Demo Box

Visirite for Banners

Eliminate unsightly unreadable banners!

Using Visirite you can ensure every outdoor banner stays presentable and readable even after some of the strongest winds.

Create this simple solution by using the following components:

- Choose your Visirite colour and size
- Cut the extrusion to size
- Add the quickcorner for extra strength
- Hold it together with the Heavy duty 90 degree bracket
- Slide it over the star picket

Visirite Demo Box

- Includes all components

Item No	Description
ET4-3200	Visirite Demo Box



Visirite Ideas



Rite Single Snapframes

Rite Mitred Snapframes



i The Rite Single SnapFrames & Rite Mitred SnapFrames come with an aluminium composite back board & a clear acrylic sleeve to protect your poster. Snap your poster in place & start promoting, it couldn't be easier!

i The Rite Single SnapFrames & Rite Mitred SnapFrames come with an aluminium composite back board & a clear acrylic sleeve to protect your poster. Snap your poster in place & start promoting, it couldn't be easier!

Rite Single Snapframes

Item No	Size(mm)	Weight	Packing
ET4-1	A4(210x297)	0.9KGS	5 Per Box
ET4-2	A3(297x420)	1.5KGS	5 Per Box
ET4-3	A2(420x594)	2.35KGS	5 Per Box
ET4-4	A1(594x841)	3.7KGS	5 Per Box
ET4-5	A0(841x1189)	4w.85KGS	5 Per Box



Each frame comes individually wrapped in a plastic bag & boxed. Each frame has clips on the back & you can either hang the frame or fix it direct to the wall by screwing through the frame.

Rite Mitred Snapframes

The Rite Mitred Snapframe presents your posters & prints in the best way possible. the frame is anodised aluminium with mitred square corners, the aluminium snaps open & shut making this frame system very user friendly.

Item No	Size(mm)	Weight	Packing
ET4-10	A4(210x297)	0.9KGS	5 Per Box
ET4-11	A3(297x420)	1.5KGS	5 Per Box
ET4-12	A2(420x594)	2.35KGS	5 Per Box
ET4-13	A1(594x841)	3.7KGS	5 Per Box
ET4-14	A0(841x1189)	4.85KGS	5 Per Box



Each frame comes individually wrapped in a plastic bag & boxed. Each frame has clips on the back & you can either hang the frame or fix it direct to the wall by screwing through the frame.

Rite Lockable Snapframes

Artesian Snapframe



Lock frame with key



Rite Lockable Snapframes

The Rite Lockable Snapframe is an elegant way of displaying your posters securely. The 4 sides of the lockable frame have to be opened in sequence. The last anodised aluminium profile is held in place with a screw on top that can be opened by key.



This system stops easy access by unauthorised people.

Item No	Size(mm)	Weight inc packing
ET4-29	A3(297x420)	1.1KGS
ET4-30	A2(420x594)	1.8KGS
ET4-31	A1(594x841)	3KGS



All frames come with an allen key to open the locked profile. Each frame comes with fixing screws & installation instructions.

Artesian Snapframe

- Available in black or anodised aluminum
- Packaged individually
- Fix to walls, fixings included
- Economical
- 25mm frame, sleek appearance

Item No	Size	Colour	Frame Width
ET4-359	A5	Anodised	25mm
ET4-365	A5	Black	25mm
ET4-360	A4	Anodised	25mm
ET4-360B	A4	Black	25mm
ET4-361	A3	Anodised	25mm
ET4-361B	A3	Black	25mm
ET4-362	A2	Anodised	25mm
ET4-362B	A2	Black	25mm
ET4-363	A1	Anodised	25mm
ET4-363B	A1	Black	25mm
ET4-364	A0	Anodised	25mm
ET4-364B	A0	Black	25mm

Metis Wall System



Rite Poster Stretcher



The poster can be easily changed via plastic gripping clips attached to springs which hold the poster in the centre & do not spoil or ruin the poster paper.

Metis Wall System

- The Metis - A brilliant guidance & directional sign system.
- PET Film included
- Cut to size

Item No	Description	Height	Graphic Height	Maximum Length
ET4-380	Metis Extrusion	68mm	52mm	3000mm
ET4-380EC	52mm Black end cap			
ET4-381	Metis Extrusion	90mm	74mm	3000mm
ET4-381EC	74mm Black end cap			
ET4-382	Metis Extrusion	120mm	105mm	3000mm
ET4-382EC	105mm Black end cap			
ET4-383	Metis Extrusion	162mm	148mm	3000mm
ET4-383EC	148mm Black end cap			

Rite Poster Stretcher

The Rite Poster Stretcher is a lightweight frame that stretches the poster taut within, from 4 corners. The frame includes 2 hangers for both wallmounting & ceiling suspending.

Item No	Size(mm)	Weight Inc Packing
ET4-70	A4(210x297)	0.22
ET4-71	A3(297x420)	0.26
ET4-72	A2(420x594)	0.32

Each stretcher is packed unassembled in a poster tube. Assembly instructions are included

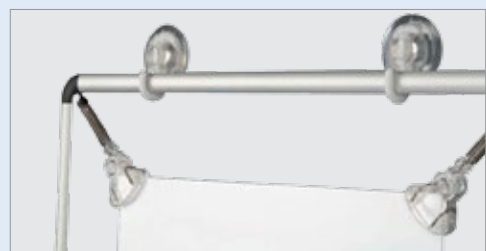

The poster is gripped in each corner

Rite Poster Display Case



Rite Notice Board With Cork



Rite Poster Display Case

Have you been having trouble with vandals stealing your posters out of the traditional snapframes or the posters been ruined by the weather? the rite poster display case prevents both!



The case comes with a key lock on the side & clear polycarbonate panel on the front to hinder access to your poster. The door can be opened 90 degrees. The anodised aluminium frame profile is 30mm deep & 45mm wide.



Item No	Size(mm)	Weight
ET4-79	A3(297x420)	2.5
ET4-80	A2(420x594)	3.75
ET4-81	A1(594x841)	5.5
ET4-82	A0 (841x1189)	10

All cases include fixing screws & installation instructions

Rite Notice Board With Cork

The Notice Board can be used in both a portrait & landscape position. The front is a clear polycarbonate panel to minimise vandalism & damage. Each unit includes a free set of pins.



The aluminium frame profile is 70mm wide & the depth of the board is 50mm. Suitable for outdoor use - weather proof.

Item No	External Size(mm)	Capacity	Weight
ET4-130	590x760	4xA4	8.6KGS
ET4-131	590x1080	6xA4	11.25KGS
ET4-132	820x1080	9xA4	14.7KGS
ET4-133	1050x1080	12xA4	17.75KGS
ET4-134	1500 x 1050	18xA4	

All Notice boards come with fixing screws & installation instructions.

Standard Standoffs



Item No	Description	Colour	Fitting Size	Hole Size	Panel Thickness
ET4-170	Standoff	Anodised Aluminium	19x25mmH	9mmD	Up to 19mm
ET4-171	Standoff	Gold	19x25mmH	9mmD	Up to 19mm
ET4-172	Standoff	Black	19x25mmH	9mmD	Up to 19mm
ET4-173	Standoff	Blue	19x25mmH	9mmD	Up to 19mm
ET4-174	Standoff	Red	19x25mmH	9mmD	Up to 19mm
ET4-175	Standoff	Chrome	19x25mmH	9mmD	Up to 19mm
ET4-178	Standoff	Anodised Aluminium	13x19mmH	8mmD	Up to 5mm
ET4-178CH	Standoff	Chrome	13x19mmH	8mmD	Up to 5mm
ET4-179	Standoff	Black	13x19mmH	8mmD	Up to 5mm



Stainless Steel Standoffs

Item No	Description	Colour	Fitting Size	Hole Size	Panel Thickness
ET4-1250	Standoff	Stainless Steel	19x25mmH	10mmD	Up to 15mm
ET4-1251	Standoff	Stainless Steel	13x19mmH	8mmD	Up to 13mm
ET4-1255	Rite Secure Standoff	Stainless Steel	18x20mmH	8mmD	Up to 10mm



Side Grip Standoff

Item No	Description	Colour	Fitting Size	Hole Size	Panel Thickness
ET4-166	Side Grip Standoff	Anodised Aluminium	25x36mmH		Up to 15mm



4 Way Standoff

Item No	Description	Colour	Fitting Size	Hole Size	Panel Thickness
ET4-165	4 Way Standoff	Anodised Aluminium	25x25mmH		Up to 8mm



LED Standoff

Item No	Description	Colour	Fitting Size	Hole Size	Panel Thickness
ET4-190	LED Standoff	Aluminium/White Light	25x325mmH	8mmD	Up to 10mm



Mirror Cap

Item No	Description	Colour	Fitting Size	Hole Size	Panel Thickness
ET4-168	Mirror Cap	Chrome	19mm	4mmD	



SmartFix Standoffs

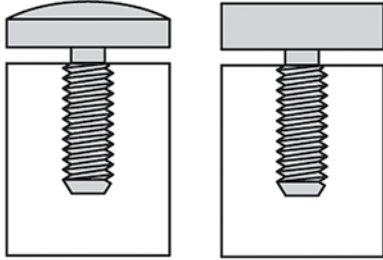

Item No	Description	Colour	Fitting Size	Hole Size	Panel Thickness
ET4-1230	Smartfix - Threaded Brass Anchor	Brass	-	-	-
ET4-1231	SmartFix Standoff - Base	Anodised Aluminium	15 x 20	6mmD	Up to 12mm
ET4-1233	SmartFix Standoff - Base	Anodised Aluminium	20 x 25	6mmD	Up to 12mm
ET4-1234	SmartFix Standoff - Base	Anodised Aluminium	20 x 45	6mmD	Up to 12mm
ET4-1235	SmartFix Standoff - Flat Top	Anodised Aluminium	15mmD	6mmD	Up to 12mm
ET4-1236	SmartFix Standoff - Domed Top	Anodised Aluminium	15mmD	6mmD	Up to 12mm
ET4-1238	SmartFix Standoff - Flat Top	Anodised Aluminium	20mmD	6mmD	Up to 12mm
ET4-1239	SmartFix Standoff - Domed Top	Anodised Aluminium	20mmD	6mmD	Up to 12mm

SmartFix Projection Support

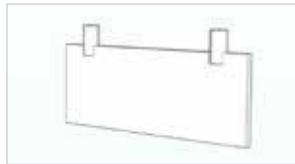
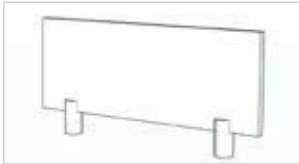

Item No	Description	Colour	Fitting Size	Hole Size	Panel Thickness
ET4-1270	SmartFix Projection Support	Anodised Aluminium	20x25mmH	-	Up to 5mm

Sign Clamps

Item No	Description	Colour	Fitting Size	Hole Size	Panel Thickness
ET4-181	Sign Clamp	Anodised Aluminium	80mm	-	Up to 8mm
ET4-182	Sign Clamp	Anodised Aluminium	180mm	-	Up to 8mm
ET4-183	Sign Clamp	Anodised Aluminium	280mm	-	Up to 8mm
ET4-184	Sign Clamp	Anodised Aluminium	380mm	-	Up to 8mm
ET4-187	Sign Clamp - Perpendicular	Anodised Aluminium	80mm	-	Up to 5mm
ET4-188	Sign Clamp - Perpendicular	Anodised Aluminium	180mm	-	Up to 5mm
ET4-189	Sign Clamp - Perpendicular	Anodised Aluminium	280mm	-	Up to 5mm
ET4-191	Sign Clamp - LED	Aluminium/White Light	180mm	-	Up to 8mm
ET4-192	Sign Clamp - LED	Aluminium/White Light	380mm	-	Up to 8mm



Letter Mounts



Sign A Bracket



Letter Mounts

The quick effective way to mount cut-out letters & panels.

- UV resistant for interior & exterior use
- Available in 3 sizes – 11mm, 15mm, 25mm standoffs.
- Very easy to install
- Packets of 100

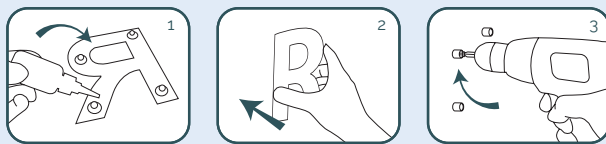

1 Adhere ball part to back of letters
 2 Place letter on wall in desired position. Centre spikes on ball part will mark positions for cup part
 3 Screw cup parts to wall

Item No	Description	Size	Pack Size
ET4-1200	Small Letter Mount	11mm	100
Et4- 1201	Medium Letter Mounts	15mm	100
Et4-1202	Large Letter Mounts	25mm	100

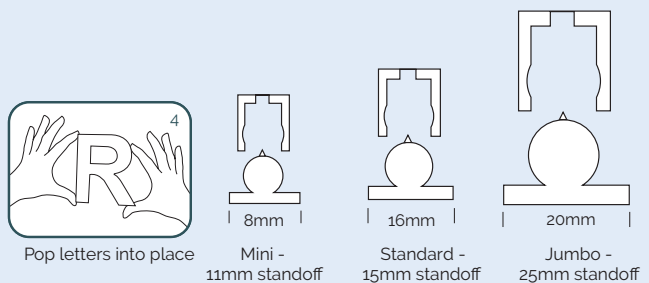

Sign A Bracket

- Holds riteflute board signs to just about anything
- Height 128mm
- UV stabilised polypropylene
- Clear
- Holds all thickness from 3mm to 6mm

Item No	Description	Size
ET4-1000	Trade Pack – 24 brackets, 5 Heavy Duty Cable Ties, 50 Securing Screws	128mm
ET4-1001	Magnet Feet Pack – Includes 2 Magnets	

Rite Cable Kit – Floor To Ceiling



Rite Cable Kit – Wall To Wall



Rite Single & Double Cable Fitting



Rite Hanging Cable Mount



Rite Cable Kit – Floor To Ceiling

Item No	Description	Cable Length
ET4-1100	Floor to ceiling cable kit – 1.5mm Cable	3000mm

Rite Cable Kit – Wall To Wall

Item No	Description	Cable Length
ET4-1101	Floor to ceiling cable kit – 1.5mm Cable	3000mm

Rite Single & Double Cable Fitting

Item No	Description	Panel Thickness
ET4-1105	Single Fitting – fits 1.5mm Cable	Holds up to 8mm
ET4-1106	Double Fitting – Fits 1.5mm Cable	Holds up to 8mm

Rite Hanging Cable Mount

- Stainless steel
- Takes a 3mm panel
- Customise hanging length

Item No	Description	Cable Length
ET4-1100CM	Stainless Steel Hanging Cable Mount	1500mm

Aluminium Wall Bar

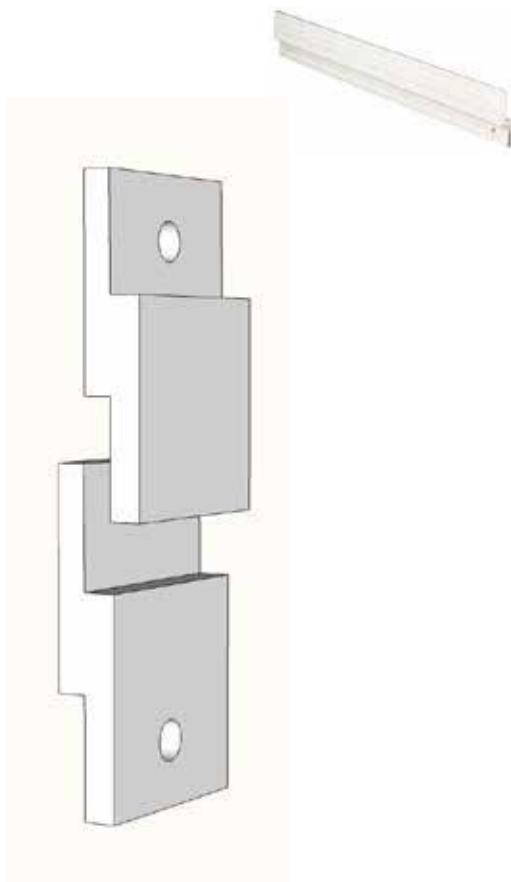

Aluminium Board Trim

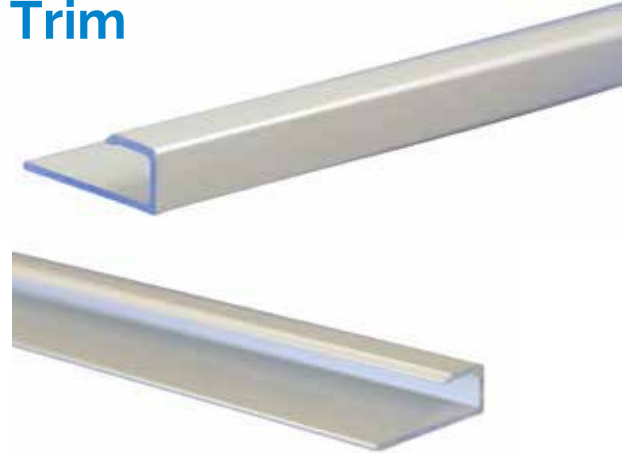

2,3,4 Way Sign Fixings



Aluminium Wall Bar

Aluminium wall bar is a great aluminium extrusion for creating hidden fixings on signs. It allows clients to easily change their signs.

Available in lengths up to 4.5m

Item No	Description
PAWB_AC	Aluminium Wall Bar - Per Metre

Aluminium Board Trim

- Takes up to a 5mm thick panel
- Anodised aluminium finish
- Discrete 8mm edge

Item No	Description
ET4-34	Board Trim - 4M Length

2,3,4 Way Sign Fixings

Item No	Description	Colour	Fitting Size	Hole Size	Panel Thickness
ET4-195	2 Way Fixing	Anodised Aluminium	20mmW	-	5mm
ET4-196	3 Way Fixing	Anodised Aluminium	20mmW	-	5mm
ET4-197	4 Way Fixing	Anodised Aluminium	20mmW	-	5mm

Chain Mesh Sign Bracket

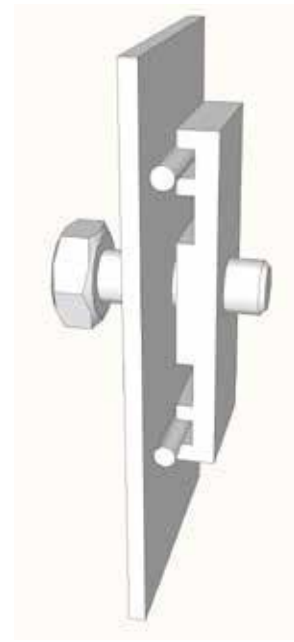
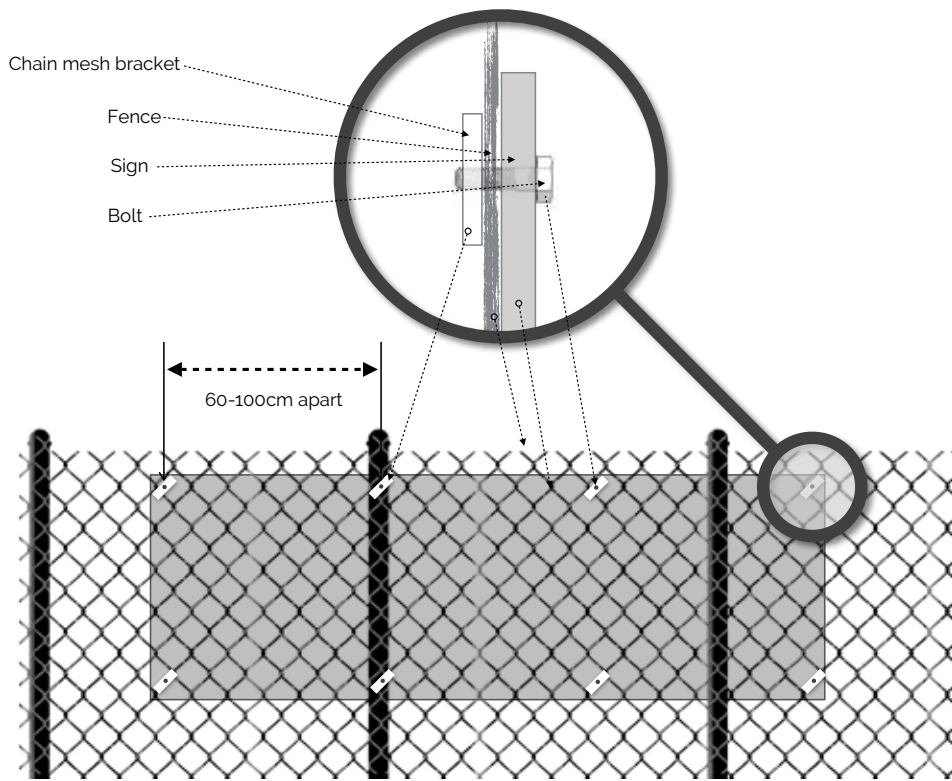

Chain Mesh Sign Bracket

Use chain mesh sign bracket to mount substrates to chain link fence!

- The most simple + affordable solution for any size chain link fence
- Mounts perfectly on chain mesh every time!
- Hangs solid & flexible substrates easily
- The right tool for the job + to keep in you tool box

Item No	Description	Size
ET4-1010	Chain Mesh Sign Bracket	70mm x 20mm



Rite Gripa Wing

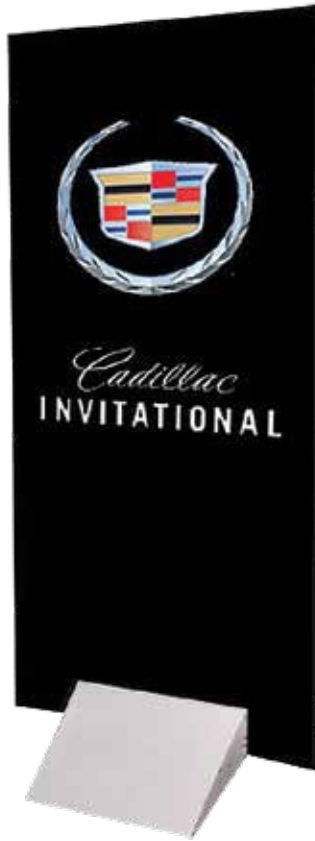

Rite Standup



Rite Gripa Wing

The Rite Gripa Sign is capable of holding signboards up to 35mm thick. Depending on the thickness of the sign the base is up to 400mm deep.



Item No	Size(mm)	Weight
ET4-160	350	3.5KGS
ET4-161	500	4.5KGS



To install you simply unwind the lock wheel place your sign in between the 2 wings & tighten the wheel, it couldn't be easier. The finish is silver.

Rite Standup

The Rite Standup has been designed to take a wide variety of different substrates and hold them vertically.

The base is 300mm wide and is made from 1.6mm sheetmetal and powdercoated black.

The height of the substrate is determined by the weight, rigidity of the panel and the location used.

The overall depth of the rite Standup is 400mm and stands 90mm tall and can take a panel up to 25mm thick.



Item No	Description
ET4-162	StandUp

SecureSign



Rite Flipover Aframe



SecureSign

Fence mesh SecureSign

- Lockon feature – held securely on 50mm fence mesh
- Bolt remains flush with the SecureSign bracket
- Stainless steel 5mm tamperproof bolt

Square tube Secure Sign

- Fits up to a 25mm x 25mm tube
- Tamperproof

Roundpost SecureSign

- 2 sizes for varying diameters – 70mm & 60mm
- Tamper resistant

Item No	Description
ET4-1010	SecureSign – Fence Mesh
ET4-1011	SecureSign – Square Tube
ET4-1012	SecureSign – Large Roundpost
ET4-1013	SecureSign – Small Roundpost
ET4-1019	SecureSign - Tool

Rite Flipover Aframe

- Fabricated in 20 x 20 tube
- Designed to fold over and protect the face
- Heavy duty bolt hinge
- Plastic stoppers on feet and top
- Panel can be either glued, riveted or double sided taped
- Panel and fixings not included

Item No	Description
ET4-220	Rite Flipover Aframe

Riteflute Roster Signs & Bollard Covers



Easy Aboard



Riteflute Roster Signs & Bollard Covers

Item No	Description	Size	Pack Size
ET4-400	ROSTER SIGN	600x300 3MM	10
ET4-401	ROSTER SIGN	600x460 3MM	10
ET4-403	ROSTER SIGN	600x750 5MM	10
ET4-404	BOLLARD COVER	270x1000 5MM	10

Easy Aboard

The Easy Aboard is an extremely cost effective aboard made from flute sheet. They are similar to the roster signs but are much easier to work with and look great!

Item No	Description	Size (doesn't include feet)
ET4-405	Easy Aboard - 3mm Flute	300W X 450H
ET4-406	Easy Aboard - 3mm Flute	600W X 600H
ET4-407	Easy Aboard - 5mm Flute	600W x 900H

Rite Metal Faced Aframe



Rite Metal Faced Aframe

- Including high quality colourbond sheet
- Easy graphics mount with optional rivets, screws and double sided tape
- Plastic coated handle
- Plastic stoppers on feet
- **NEW** heavy duty hinge and stays
- Well packaged for transport - individually
- **12 month warranty**



Item No	Size	Colour
ET4-198	600x450mm	Black Frame
ET4-199	600x600mm	Black Frame
ET4-200	600x900mm	Black Frame
ET4-210	900x1200mm	Black Frame
Et4-211	1200x1800mm	Black Frame

Rite Flute Aframe



Flute Insert Aframe with Header



Rite Flute Aframe

- Takes any panel up to 5mm thick
- Top closes close to eliminate the need for a lid.
- Plastic stoppers on feet
- **NEW heavy duty hinge (basically unbreakable) and stays**
- **Extremely durable coating – Standard colours are black and white but other colours available**
- Well packaged for transport, in a plastic bag with foam between legs
- **12 month warranty**

Item No	Size (mm)	Colour	Orientation	Weight Inc Graphics
ET4-100B	900 x 1200	Black	Portrait	9.23KGS
ET4-100W	900 x 1200	White	Portrait	9.23KGS
ET4-101B	900 x 600	Black	Portrait	5.85KGS
ET4-101W	900 x 600	White	Portrait	5.85KGS
ET4-102B	900 x 600	Black	Landscape	5.85KGS
ET4-102W	900 x 600	White	Landscape	5.85KGS
ET4-103B	750 x 500	Black	Portrait	5.3KGS
ET4-103W	750 x 500	White	Portrait	5.3KGS
ET4-104B	300 x 450	Black	Landscape	2.9KGS
ET4-104W	300 x 450	White	Landscape	2.9KGS

The A frames come in boxes of 2 & are individually packaged in plastic bags

Flute Insert Aframe with Header

- Double hinge for extra stability
- Insert size: 900 x 600mm insert
- Header size: 600 x 200mm Colourbond
- Heavy duty black powdercoat steel frame - resists rust
- Individually packed
- Plastic feet caps

Item No	Description
ET4-108	Flute Insert Aframe with Header

Rite Flute Insert Aframe – 3 colours



Declarer Aframe



Rite Flute Insert Aframe – 3 colours

- Insert size: 600 x 450mm
- Includes high quality hinges
- Panels are insert so they are not easily damaged in transport
- Lightweight but stable
- Choose the colour to suit your client – Black, Red & White
- Double sided display

Item No	Description	Colour	Size
ET4-105B	Rite Flute Insert Aframe	Black	600mm x 450mm
ET4-105W	Rite Flute Insert Aframe	White	600mm x 450mm
ET4-105R	Rite Flute Insert Aframe	Red	600mm x 450mm

Declarer Aframe

The Declarer is an extremely cost effective footpath sign mostly used internally. This is made from a durable plastic with a handle that makes it easy to use.

Great for simple signs and safety messages

- Overall height is 620mm
- Width at base is 300mm
- Width at the top is 210mm
- 0.5KGS

Item No	Description
ET4-2540	Declarer

Aframe Adapta Wheel



Ace Hinge



Aframe Adapta Wheel

Add Aframe wheels to any size of our Metal faced or flute insert Aframes! The Aframe wheels have a 70mm diameter to traverse most surfaces.

The sleeve takes a 20mm x 20mm tube and you can attach it in any direction to suit the needs of your client, you can also add them to any leg so you can add up to 4 per Aframe.

Taking ease of use to the next level!



Item No	Description
ET4-215	70mm Adapta Wheel

Ace Hinge

- Make your own custom Aframe!
- Built in self lock
- Use 2 for large aframes

Item No	Colour	Width
ET4-300	Black	350mm

Rite Plastic A-Frame



Rite Plastic A1a -Frame



Rite Flute Spinner



Rite Plastic A-Frame

- The most flexible A Frame
- Takes panels 5mm thick
- Panels 450 - 900mm W x 600 - 1500mm H
- Made from reinforced recycled fibreglass plastic



Specifically designed to accept a wide range of substrates, the RITE A-Frame is the most versatile A-frame entry into the market today

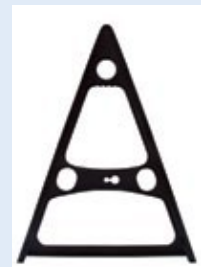

Item No	Description	Width(mm)	Depth(mm)	Height(mm)	Weight	Packing
ET4-2510	Rite Platic A Frame	700	40	920	2.45KGS	3 Per Box

Rite Plastic A1a -Frame

- The most felxible A Frame
- Takes panels up to 5mm thick
- Panel sizes 450 - 600mm W x 600mm H
- Made from reinforced recycled fibreglass plastic



Item No	Width	Depth	Height	Weight	Packing
ET4-2511	20mm	13mm	530mm	0.15KGS	5/12 Per Box

Rite Flute Spinner

- Help catch the eye!
- Add this spinner to any flute sign for added attention
- Used with 5mm flute

Item No
ET4-2530

Rite Snap A-Frame



Rite Windmaster Snapframe



Rite Blackboard A-Frame



Rite Snap A-Frame

A double sided pavement sign which enables you to snap posters into the frames. The frame & structure is completely anodised aluminium & the backing is aluminium composite board.

Item No	Size(mm)	Weight Inc Graphics
ET4-20	500x700	7.45KGS
ET4-21	A1(594x841)	9.3KGS
ET4-22	700x1000	12KGS

Each snap A-frame comes individually packed in a plastic bag & cardboard box

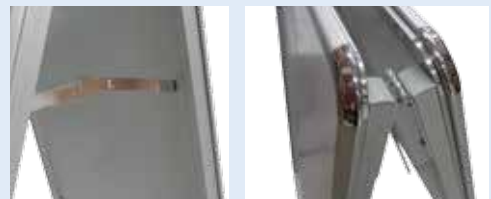

Each frame comes with a clear perspex sheet to protect your posters.

Rite Windmaster Snapframe

Designed to master the wind! Steel springs attach the double sided Snapframes to the water fillable base, the springs flexibility help keep it stable.

Item No	Size(mm)	Weight without water
ET4-150	A1(594x841)	16KGS

The product is packed unassembled with instructions to help with assembly.



The waterfillable base comes with wheels to help with the movement of these units.

Rite Blackboard A-Frame

- Heavy duty 40 x 40 frame
- 4mm Blackboard panel
- Visual size – 545mmW x 815mmH
- Heavy duty hinges

Item No	Size(mm)	Weight without water
ET4-600	Blackboard Aframe	545mmW x 815mmH

Breeze buster Panel Sign – Swinger



Breeze Buster Poster Pouch



Breeze buster Panel Sign – Swinger

- The ultimate outdoor pavement panel sign
- Totally waterproof
- 25mm x 50mm oval frame
- Metal panel included
- Water fill base for brilliant stability
- Tilt & move – wheels included
- Black base & frame
- Panel size: 588mm x 750mm
- 12 Months warranty

Item No	Description	Size
ET4-147	Black Breeze Buster with panel	588mm x 917mm

Breeze Buster Poster Pouch

- The ultimate outdoor pavement panel sign
- Totally waterproof
- 25mm x 50mm oval frame
- Poster Pouch Included
- Water fill base for brilliant stability
- Tilt & move – wheels included
- Black base & frame
- Panel size: 500mm x 750mm
- 12 Months warranty

Item No	Description	Size
ET4-146	Black Breeze Buster with Poster Pouch	588mm x 917mm



Rite Ecoflex

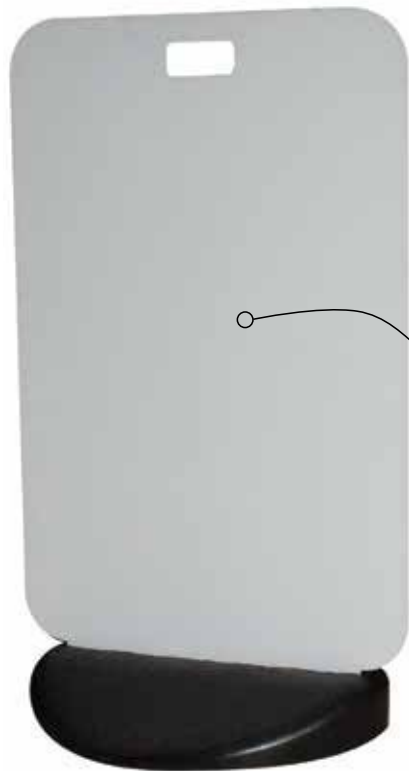

Not for high wind areas

Easy 'no tools' assembly

Carry Handle



SAFE CORNERS

Rounded corners & smooth powdercoated edge minimizes health & safety concerns

You can either insert your own board (Corflute, PVC, aluminium) or purchase our white powdercoated aluminium board.

Large display area for maximum visual impact

Rugged recycled PVC base for excellent stability & performance, surface may vary due to recycled material.

Rite Ecoflex

This new & cost efficient sign holder is perfect for pavement, roadside & forecourt promotion. The combination of low centre of gravity & flexibility with sign boards provides you with the most wind resistant, weather resistant, versatile & cost efficient sign holder available.



The base is not water fillable therefore clients are not inconvenienced by having to fill the base with water to make the system usable.



Tested in winds over 110 km/h!



Single nylon fixing
No tools required

Item No	Description	Overall Dimensions	Display Area	Weight	Colour
ET4-140	Ecoflex Base	490x90x523		8kgs	Black
ET4-141	Ecoflex Panel		460W x 783H	2kgs	White
ET4-142	600 X 900 Panel With Handle	600 x 970MM	600W x 900H	1kg	White

Rite Sign

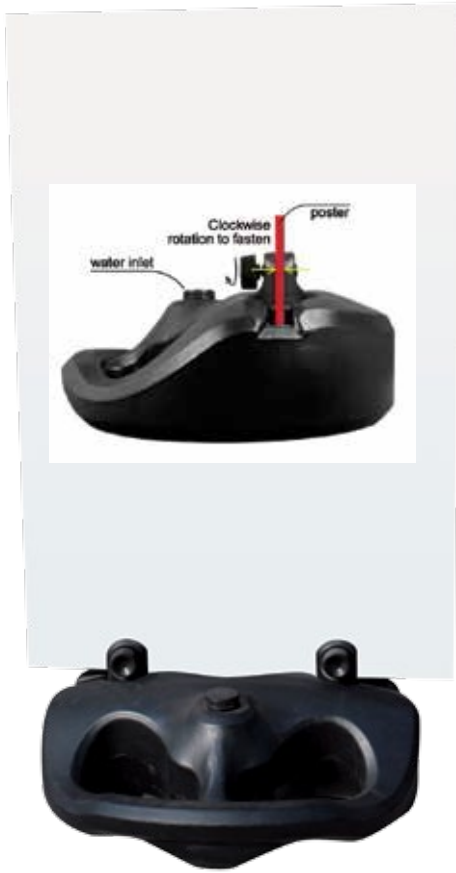

RiteWall – sign base



Rite Sign

The rite sign is a very versatile sign board holder ideal for outdoor situations. This sign holder can grip up to 10mm board. You can even use a series of these to hold very long panels. The base can be filled with water to prevent these overbalancing in various outside conditions.

Item No	Size	Colour
ET4-145	Rite Sign	Black

RiteWall – sign base

The system is lightweight, simple, highly durable, flexible & indestructible. It can be used with PVC, Forex, Foam Board, Wood, Glass & many other types of panel material.

In addition, the plastic base can be filled with water or sand for extra stability, which makes them perfect for outdoor use.

Our exclusive, lightweight & durable Rite Wall enables a quick & cost-effective solution for campaign signs, POP materials or partitions

The Rite Wall is available in these colours:

- Black • Red • Orange • Yellow • Green

Ideal for any occasion. Choose the colour that will fit your campaign best. Try Rite Wall with your cut-outs, panels & sponsor banners.

- Extremely versatile
- Eye-catching
- Durable
- Simple
- Innovation
- New
- Colourful
- Creates Attention
- Flexible
- Stable

Weight: 1.4Kg

Weight With Water: 10Kgs

Material Thickness: 10mm

Total Dimensions: 40L x 25D x 25Hmm

Item No	Description	Colour	Size	Weight
ET4-270	Rite Sign	Black	40 x 25 x 25	1.4kgs
ET4-271	Rite Sign	Green	40 x 25 x 25	1.4kgs
ET4-272	Rite Sign	Yellow	40 x 25 x 25	1.4kgs
ET4-273	Rite Sign	Orange	40 x 25 x 25	1.4kgs
ET4-274	Rite Sign	Red	40 x 25 x 25	1.4kgs

Rite Wire Stake

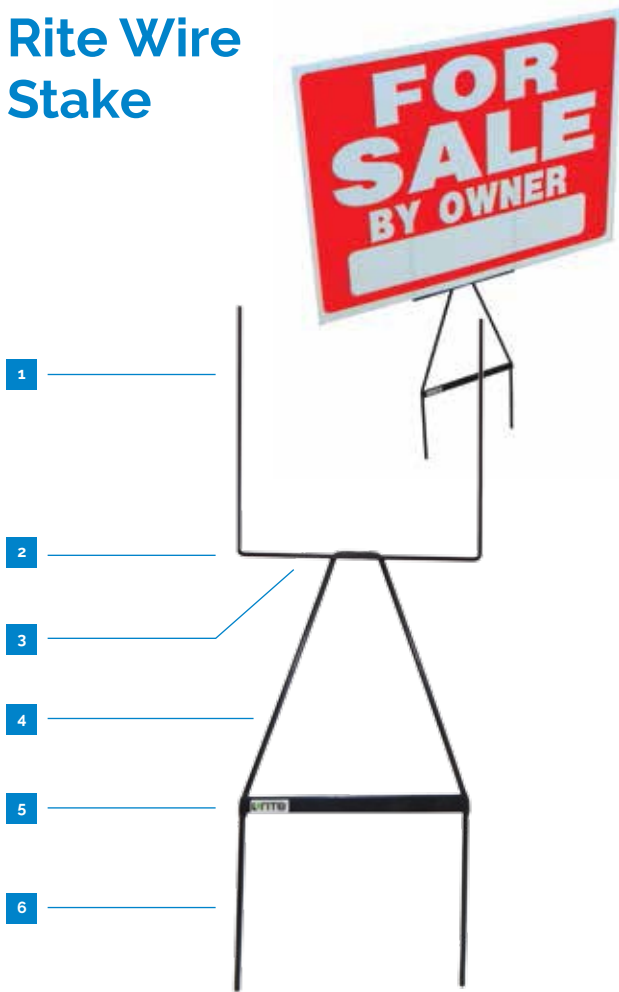

Bull Stake



Rite Wire Stake

- 1** 200mm long 3mm wire securely holds 5mm Riteflute
- 2** Tight bends to make it fit your flute neatly
- 3** Strong migweld joints to ensure they don't break easily
- 4** Tough black powdercoat finish to ensure great durability
- 5** Flat bar brace allows for branding, increases strength & helps with ground insertion
- 6** Strong 5mm wire to ensure your stakes don't bend when inserting into the ground

Item No
ET4-2504

Bull Stake

The Bull stake is our heaviest duty wire stake. They are made from 8mm rod with a flat bar at the bottom to prevent bending when inserting them in the ground. The Top section is made from 4mm wire to insert into 5mm flute sheet. These wire stakes are also taller at 400mmH to give you greater visibility at the same time not compromising with strength due to the extra thick rod structure. There is also a spot to include an extra marketing card or home open time, you can make these out of 3mm flute sheet.

- Heavy duty 8mm rod base
- Horizontal flat bar to maximise strength of step
- Accommodates 5mm thick flute sheet
- Interchangeable message spot 3mm flute sheet
- Mig welded not a weak spot weld!

Item No	Description	Size
ET4-2503	Bull Stake	40mm

Rite Window Clip



Flute Header Stake



Rite Window Clip

- Great for car yards & private sales
- Takes 5mm flute
- Takes flute sheet wider than 210mm

Item No	Description	Width(mm)	Depth(mm)	Height(mm)	Weight	Packing
ET4-2525	Rite Window Clip	20mm	13mm	530mm	0.15KGS	30 Per Box

Flute Header Stake

The Flute Header Stake allows you to add additional smaller signs to existing corflute signs.

These are great for adding home opening times to opening Signs for real estate agents or simply any corflute sign. You can even use them in conjunction with the Flute insert Aframe.

These will fit 5mm and 3mm flute sheet.

Item No	Description	Size
ET4-2506	Flute Header Stake	100mm x 300mm x 3mm

Rite Hot Dog Stand



This brand new item is an extremely low-cost, compact, patent-pending design that supports the much smaller versions of corrugated plastic & cardboard sign faces

Ritemount



low res

Rite Hot Dog Stand

- Very effective low cost design
- 200mm W taking flute 400mm W or use multiple to create long counter displays
- Recommended flute height is 100mm - 400mm
- Takes 5mm flute



Item No	Description	Width(mm)	Depth(mm)	Height(mm)	Weight
ET4-2515	Rite Hot Dog Stand	200	70	5	0.1KG

Ritemount

RITEMOUNT is an affordable easy to use sign mounting system for windows, vehicles and smooth surfaces. Simply place the RITEMOUNT system in the desired position and twist the base to secure the bracket. No additional fasteners or mounting hardware required.

Features

- One system does it all; windows, vehicles and any smooth surfaces
- The Perfect solution for attention grabbing storefront perpendicular signage.

- Installation is simple and can be completed by the end user
- Base diameter – 114mm
- Base height – 114mm
- Max weight per unit 2.72kgs
- Max media thickness 9.5mm

Item No	Description
ET4-2700	Ritemount

Road Sign Fixings

50mm Double sided aluminium Bracket

Double sided Aluminium bracket made from structural alloy. Fits over 50mm tube.



Item No	Description	Size
ET4-6001	D/S Aluminium Bracket	50mm

50mm Single Sided Aluminium Bracket

Single sided bracket to fit over 50mm post.



Item No	Description	Size
ET4-6000	Single Sided Aluminium Bracket	50mm

Cuphead Bolt & Nut

Cuphead Bolt and nut to fit the M10 Channel



Item No	Description	Size
ET4-6038	Cuphead Bolt & Nut	32mm

M10 T Bolt

The M10 Channel T bolt suits all saddle brackets.



Item No	Description	Size
ET4-6036	M 10 T Bolt	32mm
ET4-6037	M 10 T Bolt Nyloc	50mm

M10 Channel

M10 Channel comes in 6m lengths and can be used with most road sign fixings.



Item No	Description	Size
ET4-6033	M10 Channel	6M

M8 Channel

The M8 Channel comes in 4m lengths and is available in a small and medium channel.



Item No	Description	Size
ET4-6031	M8 Medium Channel	4m
ET4-6032	M8 Small Channel	4m



Blade Brackets

Blade brackets can be used for street signs and a wide range of different signs for 50mm and 65mm diameter poles. These include all fixings

Item No	Description	Size
ET4-3069	1 Way Blade Bracket	50mm x 150mm
ET4-3070	2 Way Blade Bracket	50mm x 150mm
ET4-3071	3 Way Blade Bracket	50mm x 150mm
ET4-3072	1 Way Blade Bracket	50mm x 200mm
ET4-3073	2 Way Blade Bracket	50mm x 200mm
ET4-3074	1 Way Blade Bracket	65mm x 125mm
ET4-3075	1 Way Blade Bracket	65mm x 175mm

Heavy Duty Double Bolt Clamp

Heavy Duty double bolt clamps are available in both single sided and double sided. There is both a 50mm and a 65mm version as well.



Item No	Description	Size
ET4-6002	S/S Double Bolt Clamp	50mm
ET4-6003	D/S Double Bolt Clamp	50mm
ET4-6004	S/S Double Bolt Clamp	65mm
ET4-6005	D/S Double Bolt Clamp	65mm

Banding Brackets

These Banding brackets come with bolts and washers. ET4-6027 fits a max band width of 13mm – all other sizes fit a max band width of 19mm.



Item No	Description	Size
ET4-6027	8mm Single Bolt Banding Bracket	19mmH
ET4-6028	8mm Single Bolt Banding Bracket	29mmH
ET4-6029	10mm Single Bolt Banding Bracket	29mmH
ET4-6030	8mm Double Bolt Banding Bracket	29mmH

Road Sign Fixings

Pole Saddle Bracket

Stainless steel pole saddle bracket – these take a single bolt. Bolt is not included. 5 different sizes available.



Item No	Description	Size
ET4-6006	Pole Saddle Bracket	50mm
ET4-6007	Pole Saddle Bracket	65mm
ET4-6008	Pole Saddle Bracket	80mm
ET4-6009	Pole Saddle Bracket	90mm
ET4-6010	Pole Saddle Bracket	100mm

Galvanised Stirrup

Galvanised Stirrup for 50mm & 65mm diameter poles including nut & bolts.



Item No	Description	Size
ET4-6034	Stirrup	50mm
ET4-6035	Stirrup	65mm

RHS saddle brackets

RHS Saddle brackets are available in many different sizes. Bolts are not included . All are made from Stainless steel

Item No	Description	Size
ET4-6011	RHS Saddle Bracket	50mm x 50mm
ET4-6012	RHS Saddle Bracket	75mmD x 50mmW
ET4-6013	RHS Saddle Bracket	75mm x 75mm
ET4-6014	RHS Saddle Bracket	38mmD x 76mmW
ET4-6015	RHS Saddle Bracket	89mm x 89mm
ET4-6016	RHS Saddle Bracket	100mmD x 50mmW
ET4-6017	RHS Saddle Bracket	100mm x 100mm
ET4-6018	RHS Saddle Bracket	125mmD x 75mmW
ET4-6019	RHS Saddle Bracket	150mmD x 100mmW
ET4-6020	RHS Saddle Bracket	200mmD x 100mmW
ET4-6021	RHS Saddle Bracket	250mmD x 150mmW



Stainless Steel Banding

Stainless steel banding and stainless steel banding buckles. 30 metre rolls. 100 buckles per box

Item No	Description	Size
ET4-6022	10mm S/S Band (201)	30m
ET4-6022B	10mm S/S Buckles (201)	100Pcs
ET4-6023	13mm S/S Band (201)	30m
ET4-6023B	13mm S/S Buckles (201)	100Pcs
ET4-6024	16mm S/S Band (201)	30m
ET4-6024B	16mm S/S Buckles (201)	100pcs
ET4-6025	19mm S/S Band (201)	30m
ET4-6025B	19mm S/S Buckles (201)	100Pcs
ET4-6026	Banding Tool	



Rite Swinger



Rite Swinger

The Swinger is a brilliant for road safety signs and general messages, it's very economical price makes it a great solution where appearance isn't everything. A great workhorse!

- Galvanised tube
- Tube is 25mm
- Available in 3 Sizes
- Supplied with sign attachments
- Panel not included

Item No	Description	Overall size	Panel Size
ET4-4000	Rite Swinger	750 x 950 x 25mm	600w x 600h
ET4-4001	Rite Swinger	1055 x 1010 x 25mm	900w x 600h
ET4-4002	Rite Swinger	1455 x 1310 x 25mm	1200w x 900h

Rite Boxed Edge Frame

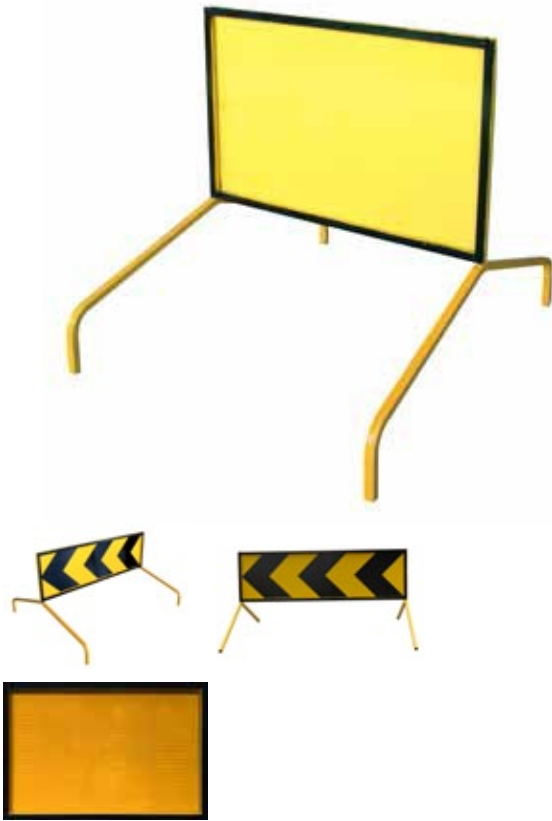

Rite Multimessage Frames

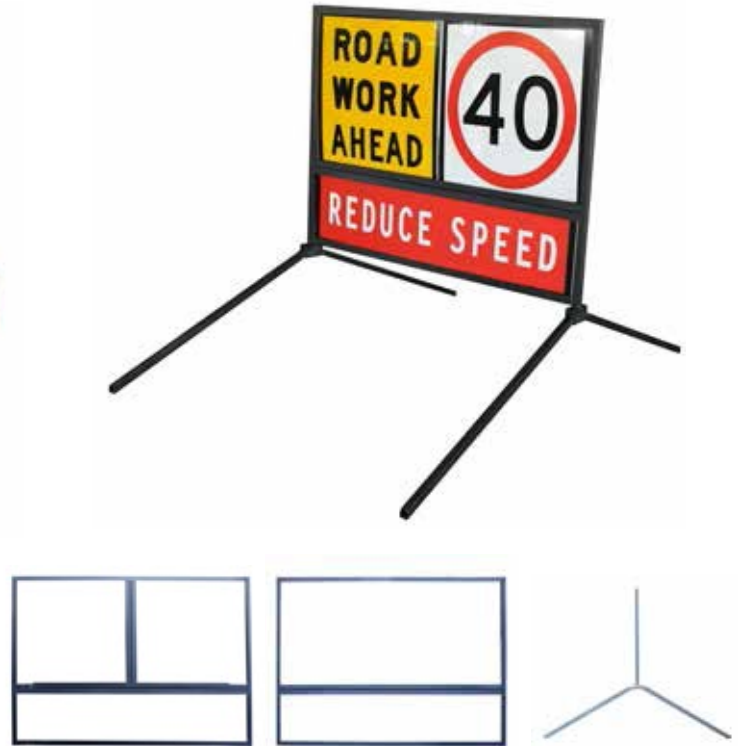

Rite Boxed Edge Frame

The Boxed Edge Frame is used for reflective signs.

The reflective sign is not included.

- Made from powder coated sheet metal
- Main frame is Yellow with a black border
- Available in 3 sizes

Item No	Description
ET4-4020	Boxed Edge - 900mmW X 600mmH
ET4-4021	Boxed Edge - 1200mmW X 900mmH
ET4-4022	Boxed Edge - 1800mmW x 300mmH
ET4-4010	Galvanised Y Leg

Rite Multimessage Frames

The Multimessage frames take up to a 5mm substrate.

These are used a lot for Road sign messages and allow you to alternate different signage between frames.

- Made from 25mm tube
- Powdercoated finish
- Overall size is 1270 x 930

Item No	Description	Panel Size
ET4-4011	Multimessage Frame - 3 Section	2 Panels 600x600 & 1 Panel 1200 x 300
ET4-4012	Multimessage Frame - 2 Section	2 Panels 600x600 & 1 Panel 1200 x 300
ET4-4010	Galvanised Y Leg	



Hanging Accessories	122
Ticketing displays	123
Menu/Price Displays	124
POS grippers	125
POS holders	126

RETAIL DISPLAYS & ACCESSORIES

Rite Hanging Accessories

Squeeze Hanging Clip

ET5-50

Squeeze sides together to attach to suspended ceiling.

Silver finish. Supplied in packs of 100.



Enhance your retail displays with the RITE display!

From ticketing systems to hanging accessories the RITE range of displays will be able to enhance your retail environment.

Slide Grip Clip

ET5-60

This clip slides onto suspended ceiling grid to allow for hanging of posters.

White. Supplied in packs of 100.



Twist'n

ET5-110

- Perfect for all foam core boards & some flute panels
- No unsightly holes

White. Supplied in packs of 100.

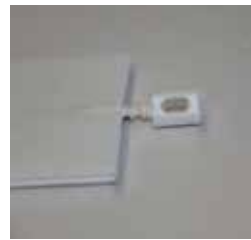

Hook'n

ET5-115

- Perfect for Hanging Flute panels
- No unsightly holes

White. Supplied in packs of 100.



Standard Hanging Hook

Double ended galvanised hook.

2mm with 16mm opening. Supplied in packs of 50.

Item	Length
ET5-80	300mm
ET5-81	600mm
ET5-82	900mm

Self Adhesive Hanging Button

ET5-70

Oval shaped with adhesive on the back for attaching to suspended ceiling grid.

Supplied in packs of 100.



RITE - Ticketing Display Systems

 Enhance your retail displays with the RITE display!

From ticketing systems to hanging accessories the RITE range of displays will be able to enhance your retail environment.

1 Standard Ticket Frames:

Sturdy plastic frames for use with your Point-of-Sale message or material. Has an opening at the top of each frame to allow for material, up to 2mm, to be slipped in.

- Ask about our special prices for larger corporate quantities.
- Frames are available in black. If large quantities are required other colours may be available.

Order Code	Size
POSF-A3	297 x 420mm (A3)
POSF-A4	210 x 297mm (A4)
POSF-A5	148 x 210mm (A5)

2 Metal Ticket Stand:

Features a sturdy stand that supports the ticket frame firmly.

- Available in black.
- Stand comes in 5 different heights.
- Frame & T-Piece not included

Order Code	Size
RSTF-MTS-1	150mm high
RSTF-MTS-3	300mm high
RSTF-MTS-6	600mm high
RSTF-MTS-9	900mm high
RSTF-MTS-12	1200mm high



T-Piece:

This "T" connector clips to other frame fittings.

Order Code
POSF-T



Magnetic Holder for frame:

Order Code
POST-MH



A Class - Card / Menu Display Systems

 Perfect for point-of-sale material



1



2



3



4

1 Sloping Single Sided Card / Menu Display:

For presentation of point-of-sale material, menus etc...

- Ask about our special prices for larger corporate quantities. Email to: sales@aclassdisplays.com.au

Order Code	Description
ADSSMD 6	Portrait A6: (105 x 148mm)
ADSSMD DL	Portrait DL: (105 x 210mm)
ADSSMD 5	Portrait A5: (148 x 210mm)
ADSSMD 4	Portrait A4: (210 x 297mm)
ADSSMD 3	Portrait A3: (297 x 420mm)
ADSSMD 6L	Landscape A6
ADSSMD DLL	Landscape DL
ADSSMD 5L	Landscape A5
ADSSMD 4L	Landscape A4
ADSSMD 3L	Landscape A3

2 Double Sided Card / Menu Display:

For presentation of point-of-sale material, menus etc...

Order Code	Description
ADSSMD 6	Portrait A6: (105 x 148mm)
ADSSMD DL	Portrait DL: (105 X 210mm)
ADSSMD 5	Portrait A5: (148 x 210mm)
ADSSMD 4	Portrait A4: (210 x 297mm)
ADSSMD 3	Portrait A3: (297 x 420mm)
ADSSMD 6L	Landscape A6
ADSSMD DLL	Landscape DL
ADSSMD 5L	Landscape A5
ADSSMD 4L	Landscape A4
ADSSMD 3L	Landscape A3

3 Curved Sloping Single Sided Card / Menu Display:

Order Code	Description
ADCSSMD 6	Portrait A6: (105 x 148mm)
ADCSSMD 5	Portrait A5: (148 x 210mm)
ADCSSMD 4	Portrait A4: (210 x 297mm)

4 Double Sleeve Wall Menu / Card Display:

Menu holders available in portrait or landscape format.

Order Code	Description
ADSWMD 1P2H	A1 Portrait – 2 Holes at Top
ADSWMD 2P2H	A2 Portrait – 2 Holes at Top
ADSWMD 3P2H	A3 Portrait – 2 Holes at Top
ADSWMD 4P2H	A4 Portrait – 2 Holes at Top
ADSWMD 5P2H	A5 Portrait – 2 Holes at Top
ADSWMD DLP2H	DL Portrait – 2 Holes at Top
ADSWMD 1L2H	A1 Landscape – 2 Holes at Top
ADSWMD 2L2H	A2 Landscape – 2 Holes at Top
ADSWMD 3L2H	A3 Landscape – 2 Holes at Top
ADSWMD 4L2H	A4 Landscape – 2 Holes at Top
ADSWMD 5L2H	A5 Landscape – 2 Holes at Top
ADSWMD DLL2H	DL Landscape – 2 Holes at Top

Suction caps, shark clips etc

Rite POS Clip:

Order Code	Description
POSClip	Rite POS Clip

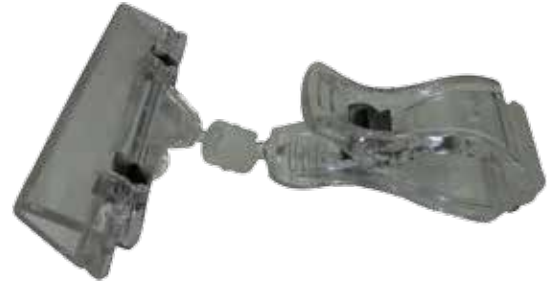

Suction Cap with Hook:

Order Code	Description
SUCCAPHK40	Suction Cap with Hook, 40mm dia
2007	Suction Cap with Hook, 20mm



Shark Clip 14mm wide base:

Sharkclip Display Holder with adhesive 14mm wide base. Length: 75mm. Accepts material up to 1.4mm thick.

Order Code	Description
SCDHAB 14	Shark Clip 14mm wide base

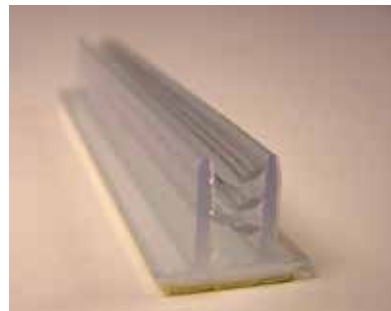

Shark Clip 28mm wide base:

Sharkclip Display Holder with adhesive 28mm wide base. Length: 75mm. Accepts material up to 1.4mm thick.

Order Code	Description
SCDHAB 28	Shark Clip 28mm wide base

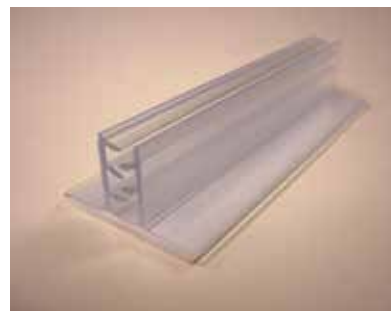

Sharkclip with Flexible Hinge between co-extruded part & adhesive T base:

Length: 75mm. Width: approx 25mm.

Order Code	Description
SCDHAB 28	Shark Clip 28mm wide base

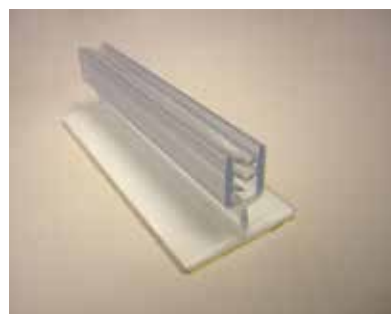

Wobblers & Data Strips

Rite Wobbler Springs with Adhesive Pads:

Spring Length: 27mm.

Order Code	Description
RWSAP	Rite Wobbler Springs



Rite Wobbler Aluminium with Adhesive Pad:

Length 73mm.

Order Code	Description
RAWAP	Rite Aluminium Wobbler



Rite – Flat Data Strips:

Adhesive data strip for retail shelf pricing. It features easy changeability. Supplied in clear. Available in 2 different lengths: 914mm or 1200mm.

Order Code	Description
FDS 26/9	Data Strip 26(w) x 914(L)mm
FDS 26/12	Data Strip 26(w) x 1200(L)mm
FDS 39/9	Data Strip 39(w) x 914(L)mm
FDS 39/12	Data Strip 39(w) x 1200(L)mm



Rite – Top Mounting Data Strips:

Adheres to top of shelving to display pricing at an easy to read angle on lower shelves. Features easy changeability. Supplied in clear. Available in 2 different lengths: 914mm or 1200mm.

Order Code	Description
TADS 26/9	Data Strip 26(w) x 914(L)mm
TADS 26/12	Data Strip 26(w) x 1200(L)mm
TADS 39/9	Data Strip 39(w) x 914(L)mm
TADS 39/12	Data Strip 39(w) x 1200(L)mm



Rite – Angled Data Strips:

This data strip adheres to front of shelving to display pricing at an easy to read angle for lower shelves. Supplied in clear. Available in 2 different lengths: 914mm or 1200mm.

Order Code	Description
FADS 26/9	Data Strip 26(w) x 914(L)mm
FADS 26/12	Data Strip 26(w) x 1200(L)mm



Rite – Hang Data Strip:

Displays label on racking, baskets, in freezers and fridges. Supplied in clear. Supplied with hanging clips. Available in 3 different lengths: 105mm, 914mm or 1200mm.

Order Code	Description
HDS 26/9	Data Strip 26(w) x 914(L)mm
HDS 26/12	Data Strip 26(w) x 1200(L)mm





Noticeboards

128-129

Suspension Rails

130

OFFICE DISPLAYS

Notice Boards



Add a prestigious look to your office or showrooms!



Notice Boards with Cork:



Magnetic Notice Boards:



Add a Pole & Base:

These displays have been designed with appearance and quality in mind. Through business to education, this range of office displays will definitely enhance your image

Notice Boards with Cork:

4 x A4, 6 x A4, 9 x A4, 12 x A4 paper capacity sizes are available. Noticeboard can be used both in portrait and landscape positions. Each unit includes a free set of pins or magnets. The profile width is 70mm and the depth of the case 50mm. The cork can be covered with Velcro compatible fabric – see page 40 for colours.

- 100% Weatherproof

Magnetic Notice Boards:

4 x A4, 6 x A4, 9 x A4, 12 x A4 paper capacity sizes are available. Noticeboard can be used both in portrait and landscape positions. Each unit includes a free set of pins or magnets. The profile width is 70mm and the depth of the case 50mm. The cork can be covered with Velcro compatible fabric – see page 40 for colours.

Add a Pole & Base:

The Notice Board with Cork & the Magnetic Notice Boards can be made free standing using this pole & base.

- Use with 4 x A4 or 6 x A4 notice boards

Order Code	External Size	Capacity
TCNB 4	590 x 760mm	4 x A4
TCNB 6	590 x 1080mm	6 x A4
TCNB 9	820 x 1080mm	9 x A4
TCNB 12	1050 x 1080mm	12 x A4

Order Code	External Size	Capacity
TMNB 4	590 x 760mm	4 x A4
TMNB 6	590 x 1080mm	6 x A4
TMNB 9	820 x 1080mm	9 x A4
TMNB 12	1050 x 1080mm	12 x A4

Order Code	Description
RPB-FSD	Pole & Base

Notice Boards

Pin-Up Board Displays:



Glass Front Notice Boards with Safety Glass:



Vitreous Porcelain Whiteboards:



Pin-Up Board Displays:

Compliment your office with this board which is stylish and economical. The durable carpet-like surface also accepts Velcro hook and loop fasteners. Available in charcoal, silver or beige.

Glass Front Notice Boards with Safety Glass:

- Lockable
- Aluminium Frame
- Front Runner Velcro Fabric

Vitreous Porcelain Whiteboards:

Order Code	Measurements
VSP 90/60	900 x 600mm
VSP 90/90	900 x 900mm
VSP 120/90	1200 x 900mm
VSP 120/120	1200 x 1200mm
VSP 150/90	1500 x 900mm
VSP 150/120	1500 x 1200mm
VSP 180/90	1800 x 900mm
VSP 180/120	1800 x 1200mm
VSP 240/120	2400 x 1200mm

Order Code	Measurements
VGFB 120/90	1200w x 900h
VGFB 120/120	1200w x 1200h
VGFB 150/90	1500w x 900h
VGFB 150/120	1500w x 1200h
VGFB 180/90	1800w x 900h
VGFB 180/120	1800w x 1200h
VGFB 210/90	2100w x 900h
VGFB 210/120	2100w x 1200h
VGFB 240/90	2400w x 900h
VGFB 240/120	2400w x 1200h

Order Code	Measurements
VWB 120/120	1200 x 1200mm
VWB 180/120	1800 x 1200mm
VWB 240/120	2400 x 1200mm
VWB 360/120	3600 x 1200mm

Suspender Systems

Suspender Paper System:



Café Rail:

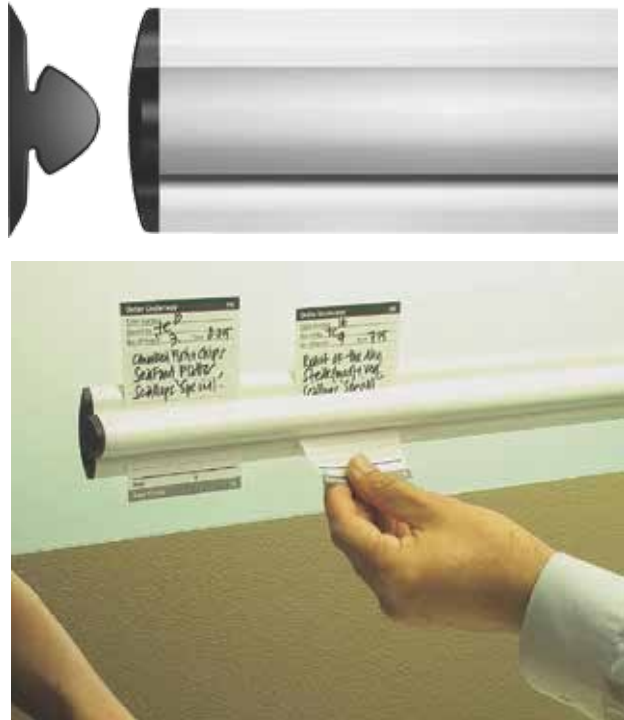

Suspender Paper System:

Elegant paper holding system for commercial & domestic use.

This system provides a simple, effective way to display your important documents. From large maps to small memos and notes, simply slip in & it's secured. The sleek form is designed to complement any modern office or workplace décor. The perfect partner for whiteboards, blackboards and pin-up boards. Used in office, factories, restaurants, supermarkets, schools & homes.

- Finish: Powder coated White (standard colour)

Café Rail:

The Versatile Docket Holding System for Cafes & Restaurants

Café Rail provides a simple, effective way to display and manage your customer orders. Use it in cafes, restaurants, take aways, the home or wherever food and drink catering is required. Designed for both horizontal and vertical use, Café Rail suits both counter use and wall mounting in the kitchen area. Café Rail's clean, appealing lines and robust finish are at home in the café/restaurant environment.

Suspender Paper System:

Order Code	Length
ACPHS3U	300mm
ACPHS4U	400mm
ACPHS5U	500mm
ACPHS6U	600mm
ACPHS7U	700mm
ACPHS8U	800mm
ACPHS9U	900mm
ACPHS10	1000mm
ACPHS12	1200mm
ACPHS15	1500mm
ACPHS18	1800mm
ACPHS20U	2000mm
ACPH22U	2200mm
ACPH24U	2400mm
ACPH26U	2600mm
ACPH28U	2800mm
ACPH30U	3000mm

Café Rail:

Order Code	Length
ACCR4	400mm
ACCR6	600mm
ACCR9	900mm
ACCR12	1200mm



Pedestal Electronic Signs

132-133

Large Format LED signs

134

ELECTRONIC SIGNAGE AND LIGHTING

Rite Gecko



Rite Komodo



Rite Gecko

Rite Gecko Digital Kiosk – is a digital advertising & informative kiosk. The eye catching digital kiosk is remote control with speakers – powerful advertising.

The Rite Gecko Digital Kiosk has a lockable USB compartment – your advertising material is safe at all times.

Suitable for retail, business, trade, office, hospitality and many other places and events.

Portable – easy to travel.

Features & Benefits:

- Eye catching
- Black – sleek design
- Remote control
- Speakers
- 21.5 TFT screen
- Housing size: 337 x 515 x 1200mm
- Indoor use only
- Lockable USB compartment
- 1yr warranty

Item No	Description	Size
Infohub1	Rite Gecko Digital Kiosk	377 x 515 x 1200mm

Rite Komodo

Rite Komodo Digital Kiosk – is a digital advertising & informative kiosk. The eye catching digital kiosk is remote control with speakers. Black sleek design.

The Rite Komodo Digital Kiosk has a lockable USB compartment – your advertising material is safe at all times.

Suitable for retail, business, trade, office, hospitality and many other places and events.

Portable – easy to travel

Features & Benefits:

- Eye catching
- Black – sleek design
- Speakers
- Remote control
- 21.5 TFT screen
- Housing size: 420 x 475 x 1665mm
- Indoor use only
- Lockable USB compartment
- 1 Yr warranty
- No IT skills required

Item No	Description	Size
Infohub4	Rite Komodo Digital Kiosk	420 x 475 x 1665mm

Rite Racehorse – Landscape



Rite Racehorse – Portrait



Rite Racehorse – Landscape

Rite Racehorse Digital Kiosk – is a digital advertising & informative kiosk. The eye catching digital kiosk is remote control with speakers. Black sleek design.

The Rite Racehorse Digital Kiosk has a lockable USB compartment – your advertising material is safe at all times.

Suitable for retail, business, trade, office, hospitality and many other places and events.

Portable – easy to travel

Features & Benefits:

- Eye catching
- Black – sleek design
- Landscape – also portrait option
- Speakers
- Remote control
- 15.6 TFT screen
- Housing size: 379 x 404 x 1133mm
- Indoor use only
- Lockable USB compartment
- 1 Yr warranty
- No IT skills required

Rite Racehorse – Portrait

Rite Racehorse Digital Kiosk – is a digital advertising & informative kiosk. The eye catching digital kiosk is remote control with speakers. Black sleek design.

The Rite Racehorse Digital Kiosk has a lockable USB compartment – your advertising material is safe at all times.

Suitable for retail, business, trade, office, hospitality and many other places and events.

Portable – easy to travel

Features & Benefits:

- Eye catching
- Black – sleek design
- Portrait – also landscape option
- Speakers
- Remote control
- 15.6 TFT screen
- Housing size: 380 x 405 x 1300mm
- Indoor use only
- Lockable USB compartment
- 1 Yr warranty
- No IT skills required

Item No	Description	Size
InfoHub2	Rite Racehorse Landscape Digital Kiosk	379 x 404 x 1133mm

Item No	Description	Size
InfoHub3	Rite Racehorse Portrait digital Kiosk	380 x 405 x 1300mm

Riteview Led Signs



Riteview Led Signs

The RITEVIEW sign system is a unique, high quality and very modular LED sign system.

RITEVIEW sign modules allow for perfect viewing of detailed signage graphics and videos.

Features of the RITEVIEW modules are as follows:

- 24 month warranty
- Easy front access for servicing and for easy installation. Back access available.
- Weatherproof – IP65/54
- Fireproof
- Extreme high brightness for daytime view
- Thin Structure - Only 120mm deep
- 960mm x 960mm Modules
- RGB LED with 100,000 hour life

The RITEVIEW sign screens are purchased in modules. All modules have the above features, The Starter Module includes the complete controlling system and every Extension module simply increases the screen size.

The RITEVIEW controlling system provided with the Starter module has the following features and details:

- Receiving Card
- Sending Card
- Win7,8,XP
- Brightness Sensor
- Monitor Card
- LED failure Detection
- Remote diagnosis
- Refresh rate 3840Hz
- 220v – Meanwell 300 power supply

Item No	Description	Module Size	Weight	View Angle	View Distance	Brightness
ET7-1	RITEVIEW - Starter	960 x 960mm	41.5kgs	140	10m+	6000cd/m2
ET7-2	RITEVIEW - Extension	960 x 960mm	41.5kgs	140	10m+	6000cd/m2



Phone: 08 - 8234 6820

Email: sales@ezybanner.com.au

Website: www.ezybanner.com.au

Address: 245a Henley Beach Rd, Torrensville, SA 5031

**SIGNAGE SOLUTIONS | LARGE FORMAT PRINTING | OFFSET PRINTING
EXHIBITION & RETAIL DISPLAYS | PROMOTIONAL ITEMS**